



motorola



---

# User's Guide

Digital Audio Baby Monitor

Models: MBP160, MBP160-2

*The features described in this User's Guide are subject to modifications without prior notice.*

# Welcome...

## *to your new Motorola Digital Audio Baby Monitor!*

Thank you for purchasing the Digital Audio Baby Monitor. Now you hear your baby sleeping in another room.

Please retain your original dated sales receipt for your records. For warranty service of your Motorola product, you will need to provide a copy of your dated sales receipt to confirm warranty status. Registration is not required for warranty coverage.

For product-related questions, please call:

**US and Canada 1-888-331-3383**  
**Email: [support@motorolamonitors.com](mailto:support@motorolamonitors.com)**

---

This User's Guide provides you with all the information you need to get the most from your product.

Before you use the digital audio baby monitor, we recommend that you insert and fully charge the battery in the parent unit, so that it continues to work if you disconnect it from the electrical outlet to carry it to another location. Please read the Safety Instructions on page 6 before you install the units.





## **Got everything?**

- 1 x Parent unit with desktop stand
- 1 x Baby unit
- 1 x Rechargeable Ni-MH battery pack for the Parent unit
- 1 x Battery door for Parent unit
- 1 x Power adapter for Parent unit
- 1 x Power adapter for Baby unit

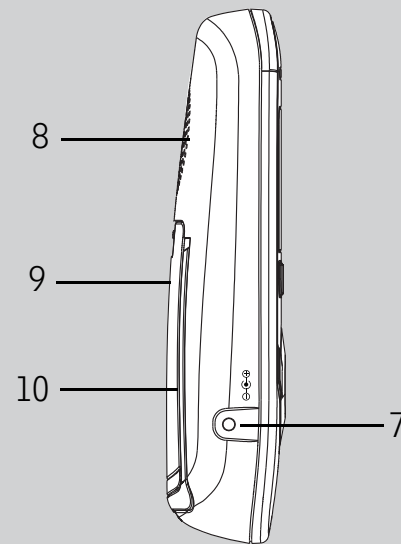
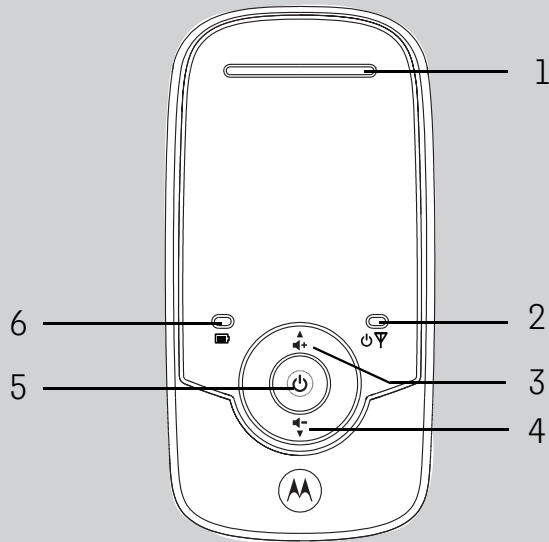
In packs with multi baby units, you will find one or more additional baby units with power adapters.

# Overview of the Parent Unit



- 1. Sound level indicator**  
It shows the sound level detected by the baby unit and the speaker volume set on the parent unit.  
Sound level detected by the baby unit:  
If no LED lights up, no sound is detected.  
If more LEDs light up, the sound level is high.  
Speaker volume on the parent unit:  
If more LEDs light up when adjusting speaker volume, the speaker volume is high.
- 2. Power/Link indicator**   
On steadily when the parent unit is powered on and linked to the baby unit.  
Off when the parent unit is powered off.  
Flashes when it is out of range of the baby unit.
- 3. UP / VOLUME +**   
Press to increase speaker volume.
- 4. DOWN / VOLUME -**   
Press to decrease speaker volume.
- 5. Power ON/OFF button**   
Press and hold to power on or off.
- 6. Charging indicator**   
On steadily when the parent unit battery is being charged.  
Flashes when the parent unit battery is low and needs charging.  
Off when the parent unit battery is fully charged, or when the battery is not installed.
- 7. Power jack**
- 8. Speaker**
- 9. Battery compartment cover**
- 10. Desktop stand**

# Overview of the Baby Unit

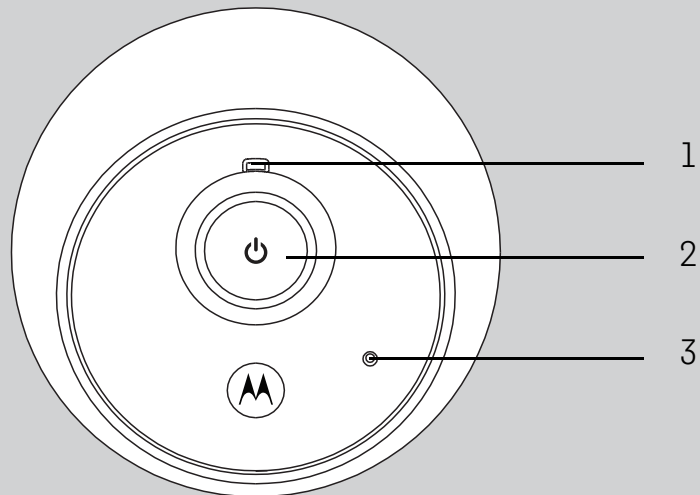

1. Power/Link indicator  
On steadily when the baby unit is powered on and linked to the parent unit.  
Off when the baby unit is powered off.  
Flashes when it is out of range of the parent unit.
2. Power ON/OFF button 
3. Microphone

## Important guidelines for installing your digital baby monitor

- To use your baby unit and parent unit together, you must be able to establish a radio link between them, and the range will be affected by environmental conditions.
- Any large metal object, like a refrigerator, a mirror, a filing cabinet, a metallic door or reinforced concrete, between the baby unit and parent unit may block the radio signal.
- The signal strength may also be reduced by other solid structures, like walls, or by radio or electrical equipment, such as TVs, computers, cordless or mobile phones, fluorescent lights or dimmer switches.
- If the signal is poor, try moving the parent unit and/or the baby unit to different positions in the rooms.

# Table of contents

<b>1. Safety Instructions .....</b>	<b>6</b>
<b>2. Getting Started.....</b>	<b>9</b>
2.1 Baby unit power supply .....	9
2.2 Parent unit battery installation and power supply .....	10
2.3 Desktop stand on parent unit.....	11
<b>3. Using Your Digital Audio Baby Monitor.....</b>	<b>12</b>
3.1 Power on or off the baby unit.....	12
3.2 Power on or off the parent unit .....	12
3.3 Adjust speaker volume of the parent unit.....	12
<b>4. Disposal of the Device (Environment).....</b>	<b>13</b>
<b>5. Cleaning .....</b>	<b>14</b>
<b>6. Troubleshooting .....</b>	<b>15</b>
<b>7. General Information .....</b>	<b>17</b>
<b>8. Technical Specifications .....</b>	<b>22</b>

## 1. Safety Instructions



### WARNING:

Strangulation Hazard. Children have **STRANGLED** in cords. Keep this cord out of the reach of children (more than 3ft (1m) away). Never use extension cords with AC Adapters. Only use the AC Adapters provided.

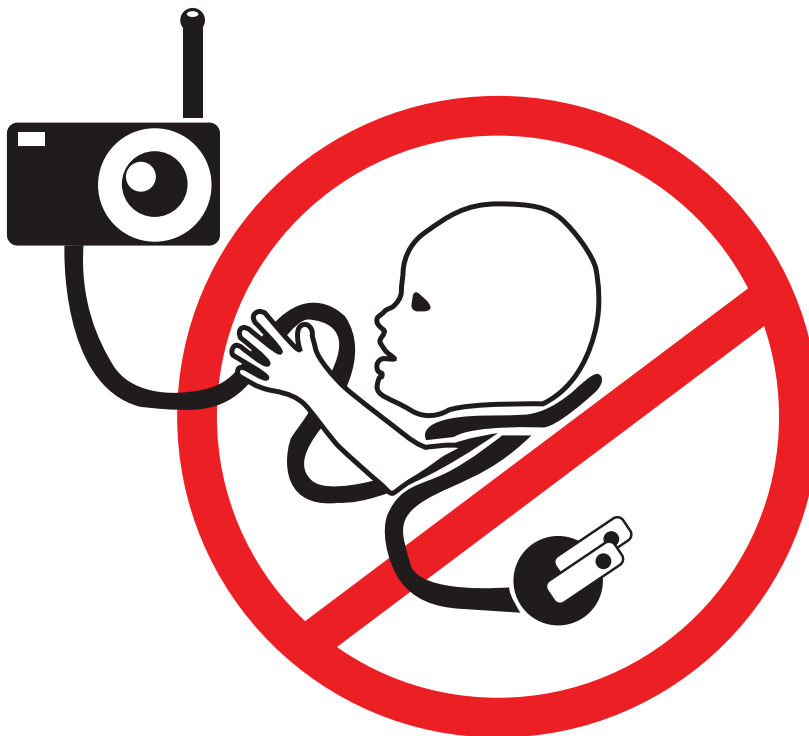

## BABY MONITOR SET UP & USE:

- Determine a location for the digital audio baby monitor that will provide the best audio reception of your baby in his/her crib.
- Place the Baby Unit on a flat surface, such as a dresser, bureau or shelf, or mount the Unit on a wall securely using the keyhole slots under the stand.
- **NEVER** place the Baby Unit or cords within the crib.

### **WARNING**

*This Digital Audio Baby Monitor is compliant with all relevant standards regarding electromagnetic fields and is, when handled as described in the User's Guide, safe to use. Therefore, always read the instructions in this User's Guide carefully before using the device.*

- Adult assembly is required. Keep small parts away from children when assembling.
- This product is not a toy. Do not allow children to play with it.
- This Digital Audio Baby Monitor is not a substitute for responsible adult supervision.
- Keep this user's guide for future reference.
- Keep the cords out of reach of children.
- Do not cover the Digital Audio Baby Monitor with a towel or blanket.
- Test this monitor and all its functions so that you are familiar with it prior to actual use.
- Do not use the Digital Audio Baby Monitor in damp areas or close to water.
- Do not install the Digital Audio Baby Monitor in extreme cold or heat, direct sunlight, or close to a heat source.
- Only use the chargers and power adapters provided. Do not use other chargers or power adapters as this may damage the device and battery pack.
- Only insert a battery pack of the same type.
- Do not touch the plug contacts with sharp or metal objects.
- Connect the power adapters to easily accessible electrical outlets.

**CAUTION**

*There is a risk of explosion if the battery is replaced by an incorrect type.*

*Dispose of used batteries according to the instructions.*

*Use only rechargeable battery pack with rating: 2.4V 400mAh*



## 2. Getting Started

### 2.1 Baby unit power supply

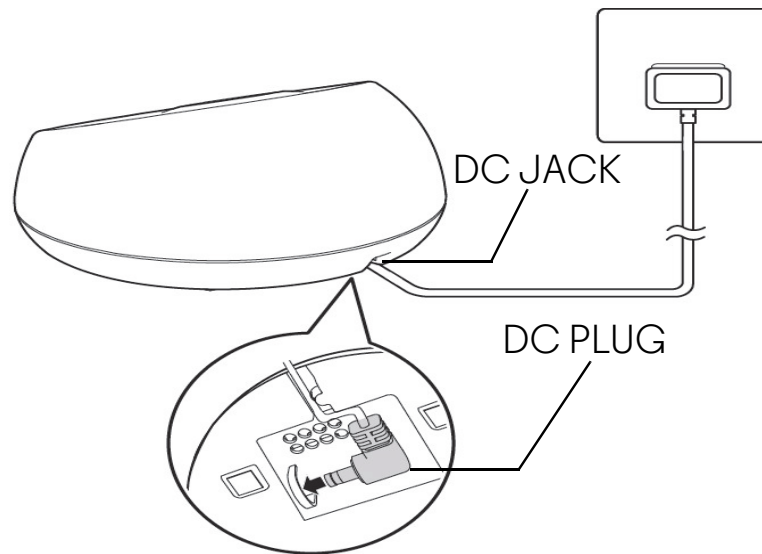

1. Insert the DC plug of the power adapter with the bigger DC plug into the DC jack on the back of the baby unit.
2. Connect the other end of the power adapter to a suitable electrical outlet.

#### **NOTE**

*Only use the provided power adapter.*

## 2.2 Parent unit battery installation and power supply

A rechargeable battery pack is supplied and should be fitted, so that the parent unit can be carried to another location without losing the link with the baby unit(s). Charge the parent unit before using it for the first time or when the parent unit indicates that battery is low. We recommend that the unit be charged for 15 hours prior to first use.

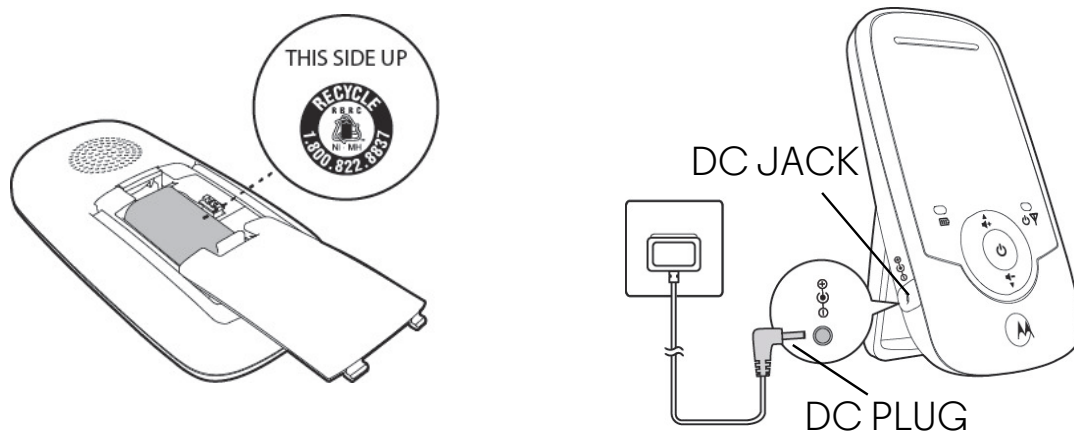

1. Slide off the battery compartment cover.
2. Insert the plug of the rechargeable battery pack into the jack inside the battery compartment.
3. Fit the battery pack into the compartment, with the label THIS SIDE UP facing up.
4. Slide the battery compartment cover back until it clicks into place.
5. Insert the DC plug of the power adapter with the smaller DC plug into the DC jack on the side of the parent unit.
6. Connect the other end of the power adapter to a suitable electrical outlet.
7. The charging indicator comes on.

### NOTE

*Only use the provided power adapter and battery pack.*

*We recommend that you install and fully charge the battery in the parent unit, so that it continues to work if you disconnect it from the electrical outlet to carry it to another location.*

## 2.3 Desktop stand on parent unit

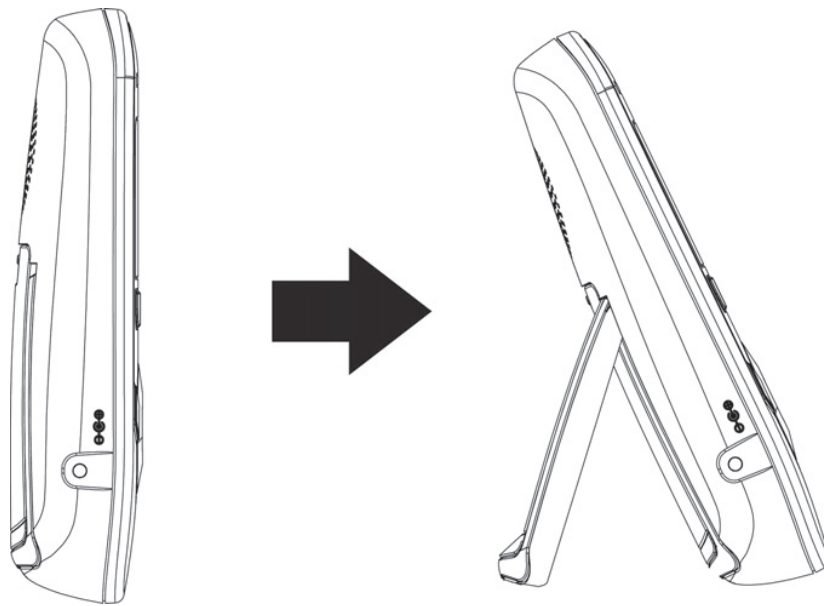

The parent unit comes with a desktop stand attached to the back of the unit. To place the parent unit on a desk, simply pull out the stand, as shown above.



**NOTE**

*Place the parent unit on a flat, even surface.*



## 3. Using Your Digital Audio Baby Monitor

Please read these instructions carefully, and be aware that this digital audio baby monitor is only intended as an aid. It is not a substitute for responsible and proper adult supervision.

### 3.1 Power on or off the baby unit

- Press and hold  to power on the baby unit. The Power/Link indicator turns on.
- Press and hold  again to power off the baby unit. The Power/Link indicator turns off.

### 3.2 Power on or off the parent unit

- Press and hold  to power on the parent unit. The Power/Link indicator turns on.
- Press and hold  again to power off the parent unit. The Power/Link indicator turns off.



#### **NOTE**

*If you place the parent and baby units too close together, you may hear a high pitched noise. This is not a fault. The units are designed to be operated at some distance apart, e.g. in separate rooms, so move the units further apart.*

*If the Power/Link indicator flashes on the baby unit or parent unit, they are not linked to each other. Make sure that both units are powered on, and reduce the distance between the units, but not closer than 3 feet.*

### 3.3 Adjust speaker volume of the parent unit

You can adjust the speaker volume from Volume 1 to Volume 3, or turn it off.

- Press  or  on the parent unit when it is not in use.  
The sound level indicator lights up when you adjust the speaker volume.  
The number of LED lights indicate how loud the volume has been raised.

## 4. Disposal of the Device (Environment)

At the end of the product lifecycle, you should not dispose of this product with normal household waste. Take this product to a collection point for the recycling of electrical and electronic equipment. The symbol on the product, user's guide and/or box indicates this.

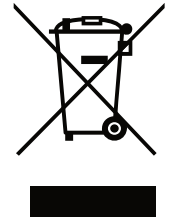

Some of the product materials can be re-used if you take them to a recycling point. By reusing some parts or raw materials from used products you make an important contribution to the protection of the environment.

Please contact your local authorities in case you need more information on the collection points in your area.

Dispose of the battery pack in an environmentally-friendly manner according to your local regulations.

## 5. Cleaning

Clean your Digital Audio Baby Monitor with a slightly damp cloth or with an anti-static cloth. Never use cleaning agents or abrasive solvents.

### Cleaning and care

- Do not clean any part of the Digital Audio Baby Monitor with thinners or other solvents and chemicals - this may cause permanent damage to the product which is not covered by the warranty.
- Keep your Digital Audio Baby Monitor away from hot, humid areas or strong sunlight, and do not let it get wet.
- Every effort has been made to ensure high standards of reliability of your Digital Audio Baby Monitor. However, if something does go wrong, please do not try to repair it yourself - contact Customer Service for assistance.

### **IMPORTANT**

*Always switch off and disconnect the power adapter before cleaning your digital baby monitor.*

## 6. Troubleshooting

### Power/Link Indicator on the parent unit does not come on

- Check whether the parent unit is powered on.
- Check whether the supplied battery pack is correctly installed and that they are not drained.
- Recharge the parent unit by connecting it to the electrical outlet.

### Power/Link Indicator on the baby unit flashes

- The parent unit and the baby unit may be out of range with each other. Reduce the distance between the units, but not closer than 3 feet.
- The baby unit may be powered off. Press and hold  to power on the baby unit.

### Charging Indicator on the parent unit screen flashes

- Battery pack in the parent unit is running low. Connect the parent unit to the electrical outlet with the supplied power adapter for recharging.

### The parent unit beeps

- The parent unit may have lost connection with the baby unit. Reduce the distance between the parent unit and the baby unit, but not closer than 3 feet.
- The baby unit may be powered off. Press and hold  to power on the baby unit.
- Battery pack in the parent unit is running low. Connect the parent unit to the electrical outlet with the supplied power adapter for recharging.

### Cannot hear sound or baby cry from the parent unit

- The volume level in the parent unit may be set too low, increase the volume level of the parent unit. Refer to section 3.3 for volume level settings.
- The parent unit and the baby unit may be out of range with each other. Reduce the distance between the units, but not closer than 3 feet.

## **The digital baby monitor system produces a high-pitched noise**

- The parent unit and the baby unit are too close to each other. Make sure that the parent unit and baby unit are at least 3 feet away from each other.
- The speaker volume of the parent unit may be set too high. Decrease the volume of the parent unit. Refer to section 3.3 for volume level settings.

## **Battery pack in the parent unit is running low quickly**

- The volume level of the parent unit may be set too high, which consumes power. Decrease the volume level of the parent unit. Refer to section 3.3 for volume level settings.



## 7. General Information

If your product is not working properly...

1. Read this User's Guide or the Quick Start Guide.
2. Visit our website: [www.motorola.com](http://www.motorola.com)
3. Contact Customer Service at

US and Canada 1-888-331-3383

Email: [support@motorolamonitors.com](mailto:support@motorolamonitors.com)

To order a replacement battery pack for parent unit, contact customer service.

### **Consumer Products and Accessories Limited Warranty ("Warranty")**

Thank you for purchasing this Motorola branded product manufactured under license by Binatone Electronics International LTD ("BINATONE")

#### ***What Does this Warranty Cover?***

Subject to the exclusions contained below, BINATONE warrants that this Motorola branded product ("Product") or certified accessory ("Accessory") sold for use with this product that it manufactured to be free from defects in materials and workmanship under normal consumer usage for the period outlined below. This Warranty is your exclusive warranty and is not transferable.

#### ***Who is covered?***

This Warranty extends only to the first consumer purchaser, and is not transferable.

#### ***What will BINATONE do?***

BINATONE or its authorized distributor at its option and within a commercially reasonable time, will at no charge repair or replace any Products or Accessories that does not conform to this Warranty. We may use functionally equivalent reconditioned/ refurbished/ pre-owned or new Products, Accessories or parts.

### ***What Other Limitations Are There?***

ANY IMPLIED WARRANTIES, INCLUDING WITHOUT LIMITATION THE IMPLIED WARRANTIES OF MERCHANTABILITY AND FITNESS FOR A PARTICULAR PURPOSE, SHALL BE LIMITED TO THE DURATION OF THIS LIMITED WARRANTY, OTHERWISE THE REPAIR OR REPLACEMENT PROVIDED UNDER THIS EXPRESS LIMITED WARRANTY IS THE EXCLUSIVE REMEDY OF THE CONSUMER, AND IS PROVIDED IN LIEU OF ALL OTHER WARRANTIES, EXPRESS OR IMPLIED. IN NO EVENT SHALL MOTOROLA OR BINATONE BE LIABLE, WHETHER IN CONTRACT OR TORT (INCLUDING NEGLIGENCE) FOR DAMAGES IN EXCESS OF THE PURCHASE PRICE OF THE PRODUCT OR ACCESSORY, OR FOR ANY INDIRECT, INCIDENTAL, SPECIAL OR CONSEQUENTIAL DAMAGES OF ANY KIND, OR LOSS OF REVENUE OR PROFITS, LOSS OF BUSINESS, LOSS OF INFORMATION OR OTHER FINANCIAL LOSS ARISING OUT OF OR IN CONNECTION WITH THE ABILITY OR INABILITY TO USE THE PRODUCTS OR ACCESSORIES TO THE FULL EXTENT THESE DAMAGES MAY BE DISCLAIMED BY LAW.

Some jurisdictions do not allow the limitation or exclusion of incidental or consequential damages, or limitation on the length of an implied warranty, so the above limitations or exclusions may not apply to you. This Warranty gives you specific legal rights, and you may also have other rights that vary from one jurisdiction to another.

<b>Products Covered</b>	<b>Length of Coverage</b>
Consumer Products	<b>One (1) year</b> from the date of the products original purchase by the first consumer purchaser of the product.
Consumer Accessories	<b>Ninety (90) days</b> from the date of the accessories original purchase by the first consumer purchaser of the product.
Consumer Products and Accessories that are Repaired or Replaced	<b>The balance of the original warranty or for Ninety (90) days</b> from the date returned to the consumer, whichever is longer.

### Exclusions

**Normal Wear and Tear.** Periodic maintenance, repair and replacement of parts due to normal wear and tear are excluded from coverage.

**Batteries.** Only batteries whose fully charged capacity falls below 80% of their rated capacity and batteries that leak are covered by this Warranty.

**Abuse & Misuse.** Defects or damage that result from: (a) improper operation, storage, misuse or abuse, accident or neglect, such as physical damage (cracks, scratches, etc.) to the surface of the product resulting from misuse; (b) contact with liquid, water, rain, extreme humidity or heavy perspiration, sand, dirt or the like, extreme heat, or food; (c) use of the Products or Accessories for commercial purposes or subjecting the Product or Accessory to abnormal usage or conditions; or (d) other acts which are not the fault of MOTOROLA or BINATONE., are excluded from coverage.

**Use of Non-Motorola branded Products and Accessories.** Defects or damage that result from the use of Non-Motorola branded or certified Products or Accessories or other peripheral equipment are excluded from coverage.

**Unauthorized Service or Modification.** Defects or damages resulting from service, testing, adjustment, installation, maintenance, alteration, or modification in any way by someone other than MOTOROLA, BINATONE or its authorized service centers, are excluded from coverage.

**Altered Products.** Products or Accessories with (a) serial numbers or date tags that have been removed, altered or obliterated; (b) broken seals or that show evidence of tampering; (c) mismatched board serial numbers; or (d) nonconforming or non-Motorola branded housings, or parts, are excluded from coverage.

**Communication Services.** Defects, damages, or the failure of Products or Accessories due to any communication service or signal you may subscribe to or use with the Products or Accessories is excluded from coverage.

### ***How to Obtain Warranty Service or Other Information?***

To obtain service or information, please call:

US and Canada 1-888-331-3383

Email: [support@motorolamonitors.com](mailto:support@motorolamonitors.com)

You will receive instructions on how to ship the Products or Accessories at your expense and risk, to a BINATONE Authorized Repair Center.

To obtain service, you must include: (a) the Product or Accessory; (b) the original proof of purchase (receipt) which includes the date, place and seller of the Product; (c) if a warranty card was included in your box, a completed warranty card showing the serial number of the Product; (d) a written description of the problem; and, most importantly; (e) your address and telephone number.

These terms and conditions constitute the complete warranty agreement between you and BINATONE. regarding the Products or Accessories purchased by you, and supersede any prior agreement or representations, including representations made in any literature publications or promotional materials issued by BINATONE. or representations made by any agent employee or staff of BINATONE, that may have been made in connection with the said purchase.

## FCC, ACTA and Industry Canada (IC) Regulations

**Warning:** Changes or modifications to this equipment not expressly approved by the party responsible for compliance could void the user's authority to operate the equipment.

**NOTE:** This equipment has been tested and found to comply with the limits for a Class B digital device, pursuant to Part 15 of the FCC Rules. These limits are designed to provide reasonable protection against harmful interference in a residential installation. This equipment generates, uses and can radiate radio frequency energy and, if not installed and used in accordance with the instructions, may cause harmful interference to radio communications.

However, there is no guarantee that interference will not occur in a particular installation. If this equipment does cause harmful interference to radio or television reception, which can be determined by turning the equipment off and on, the user is encouraged to try to correct the interference by one or more of the following measures:

- Reorient or relocate the receiving antenna.
- Increase the separation between the equipment and receiver.
- Connect the equipment into an outlet on a circuit different from that to which the receiver is connected.
- Consult the dealer or an experienced radio/TV technician for help.

This device complies with part 15 of the FCC Rules. Operation is subject to the following two conditions: (1) This device may not cause harmful interference, and (2) this device must accept any interference received, including interference that may cause undesired operation.

This device complies with Industry Canada licence-exempt RSS standard(s). Operation is subject to the following two conditions: (1) this device may not cause interference, and (2) this device must accept any interference, including interference that may cause undesired operation of the device.

This product meets the applicable Industry Canada technical specifications.

This Class B digital apparatus complies with Canadian requirement: CAN ICES-3(B)/NMB-3(B)

**Caution:** To maintain the compliance with the FCC's RF exposure guideline, place the baby unit at least 20 cm from nearby persons.

For body worn operation, the parent unit has been tested and meets the FCC RF exposure guidelines when used with the belt clip supplied or designated for this product. Use of other accessories may not ensure compliance with FCC RF exposure guide lines.

---

## 8. *Technical Specifications*

### **BABY UNIT:**

---

Frequency	1921.536 - 1928.448 MHz
Channels	10
Operating temperature	41°F - 113°F
Power supply adapter	Input 100-240Vrms
Rating	Output 6VDC, 450mA

---

### **PARENT UNIT:**

---

Frequency	1921.536 - 1928.448 MHz
Channels	10
Operating temperature	41°F - 113°F
Battery rating	2.4V 400mAh Ni-MH battery pack
Power supply adapter	Input 100-240Vrms
Rating	Output 6VDC, 450mA

---

Specifications are subject to change without prior notice.



Manufactured, distributed or sold by Binatone Electronics International LTD., official licensee for this product. MOTOROLA and the Stylized M Logo, are trademarks or registered trademarks of Motorola Trademark Holdings, LLC. and are used under license. All other trademarks are the property of their respective owners.

© 2014 Motorola Mobility LLC. All rights reserved.



US\_EN Version 4.0

Printed in China