

KUMO

Installation and Operation Guide

Version 3.1r3

Published: November 20, 2015

**KUMO
1604**



**KUMO
1616**



KUMO CP



**KUMO
3232**



Because it matters.™

AJA[®]
VIDEO SYSTEMS

Table of Contents

Notices	5
Trademarks	5
Copyright	5
Contacting Support	5
Chapter 1: Introduction	6
Overview	6
KUMO Features	7
KUMO Connections	7
P/S 1 & P/S 2 Power Connectors	7
Power Loss Recovery	8
RJ45 Ethernet Connector	8
ID and Reset	8
REF BNC connector	8
Video Inputs and Outputs	8
Normal mode	8
Dual and Quad modes	8
RS-422 DB9 Connector	9
Older Model RS-422 Adapter	9
KUMO Control and Monitoring	9
Network Configuration Overview	9
Direct Connection	9
LAN Connection Using a Hub or Switch	10
Default Network Settings	10
In This Manual	11
Chapter 2: Installation	12
Introduction	12
What's In The Box?	12
KUMO Chassis Installation	13
Where to Place KUMO	13
Physical Requirements	13
Power Requirements	13
Physical Equipment Setup	14
Quick Start Configuration	14
Default Auto Configure KUMO Router and CP	14
DHCP on an Existing Network	14
Computer Auto Discovery	15
Mac Configuration with Safari Browser Using Bonjour	15
Windows 7 PC Configuration using UPnP	16
KUMO Temporary Static IP Address	16
Network Configuration Overview	18
Direct Connection	19
LAN Connection Using a Hub or Switch	19
Setup and Control Methods	20
Setup and Control from a Browser on Mac OSX	21
Safari Browser Using Bonjour	21
Safari Browser: Type in KUMO Static IP Address	21
Setup and Control from a Browser on Windows 7	22
Windows 7: Using UPnP (Universal Plug and Play)	23

Windows 7: Firefox Using Bonjour	23
Install Apple Bonjour Print Services for Windows.....	23
Install DNSSD for Firefox Add-On	24
Accessing KUMO Devices in Firefox.....	26
Windows 7 Browser: Type in KUMO Static IP Address	26
Setup and Control from a Browser on Windows XP	28
Windows XP using UPnP (Universal Plug and Play)	28
Enabling UPnP Services in Windows XP.....	28
Windows XP: Firefox Using Bonjour.....	29
Windows XP Browser: Type in KUMO Static IP Address.....	29
Larger System Control Configurations.....	31
TCP-IP Network Connection	32
Default DHCP Configuration	32
Static IP Configuration	32
Select KUMO to Control from Webpage.....	33
Assign KUMO CP to Control KUMO Routers	33
Chapter 3: KUMO Router Web Browser User Interface	35
Introduction	35
Navigation Bar Information.....	35
KUMO Home.....	36
Control Panel Operation	36
Router Configuration.....	36
Mode Selection	36
Button Settings	37
Network Setup.....	38
Firmware Updating	38
Unpack the Software.....	39
Uploading and Installing Firmware to KUMO.....	39
Safeboot Reset.....	41
KUMO Alarms.....	41
Locating a Specific KUMO	42
Chapter 4: KUMO Remote Control Panel	43
Connectors and Indicator	43
Button Key Caps	44
Panel Function Buttons.....	44
Panel Lock.....	44
Destination Lock.....	44
Router Delegation Buttons (RTR 1 - 4).....	45
Shift/Reset Buttons	45
Control Panel Browser Interface	45
Home Page.....	45
Configuration Page	46
Network Page	46
Identify Button	46
Appendix A: Specifications	48
KUMO SDI Router Specifications	48
KUMO CP Specifications	49
GVG Native Protocol Support	49
RS-422 Control Specifications.....	50
Ethernet Control Specifications	50

Appendix B: Safety & Compliance	51
Federal Communications Commission (FCC) Compliance Notices	51
Class A Interference Statement	51
FCC Caution	51
Canadian ICES Statement	51
European Union and European Free Trade Association (EFTA)	
Regulatory Compliance	52
Declaration of Conformity	52
Korea KCC Compliance Statement	53
Taiwan Compliance Statement	53
Japanese Compliance Statement	53
Translated Warning and Caution Messages	53
Before Operating Please Read These Instructions	54
Warranty Information	64
Limited Warranty	64
Index	65

Notices

Trademarks

AJA®, Io®, Ki Pro®, KONA®, KUMO®, T-TAP®, Because it matters.® and ROI® are registered trademarks of AJA Video Systems, Inc. in the United States. AJA and Ki Pro are trademarks of AJA Video Systems, Inc. registered in other countries. AJA Control Room™, CION™, Corvid Ultra™, FiDO™, Science of the Beautiful™, TruScale™, TruZoom™, V2Analog™ and V2Digital™ are trademarks of AJA Video Systems, Inc.

AirPort, Apple, Apple logo, AppleShare, AppleTalk, FireWire, iPod, iPod touch, Mac and Macintosh are registered trademarks of Apple Inc. Final Cut Pro, QuickTime and QuickTime logo are trademarks of Apple Inc.

Avid, Avid DNxHD and Media Composer are registered trademarks of Avid Technology, Inc.

HDMI, the HDMI logo and High-Definition Multimedia Interface are trademarks or registered trademarks of HDMI Licensing, LLC.

DVI is a registered trademark of DDWG.

TASCAM is a registered trademark of TEAC Corporation.

Dolby® and the double-D Dolby logo are registered trademarks of Dolby Laboratories Licensing Corporation.

All other trademarks are the property of their respective holders.

Copyright

Copyright © 2015 AJA Video Systems, Inc. All rights reserved. All information in this manual is subject to change without notice. No part of the document may be reproduced or transmitted in any form, or by any means, electronic or mechanical, including photocopying or recording, without the express written permission of AJA Video Systems, Inc.

Contacting Support

When calling for support, have all information at hand prior to calling.

To contact AJA for sales or support, use any of the following methods:

Telephone: +1.530.271.3190

FAX: +1.530.271.3140

Web: <http://www.aja.com>

Support Email: support@aja.com

Sales Email: sales@aja.com

Chapter 1: Introduction



Overview

KUMO compact SDI routers are small and cost-effective, yet robust and reliable. KUMO supports full-broadcast specifications over SDI, HD-SDI, and 3G-SDI. Additionally, KUMO routers support SDI related protocols such as 270mb ASI and Canon 3G-SDI RAW. Kumo routers are re-clocking, non-blocking, and ready for any broadcast, production, or post production environment. Running Embedded Linux, KUMO routers support powerful HTTP control and monitoring. KUMO contains an internal webserver that allows immediate installation, configuration, and operation without requiring additional software. It offers a powerful user interface via any standard web browser. KUMO SDI routers are available in three configurations:

- KUMO 1604 - up to sixteen SDI inputs and four outputs
- KUMO 1616 - up to sixteen SDI inputs and sixteen outputs
- KUMO 3232 - up to thirty-two SDI inputs and thirty-two outputs

KUMO also supports dual and quad port switching modes which simplify multi port SDI signals such as "dual link" and 4K "quad-link", or switching 2 or 4 sources at once for any reason.

Because of their compact 1RU and 2 RU sizes, KUMO SDI routers are ideal for space-sensitive applications such as mobile sports trucks, edit suites, corporate video installations, or live theatrical A/V rigs.

KUMO Features

The KUMO routers offer the following features for ease of use in any environment:

- Support for SD-SDI, HD-SDI, 3G-SDI, SMPTE 259M/292M/424M
- KUMO v3.0 firmware supports dual and quad mode routing, allowing users to group together inputs and outputs for multiple cable applications like Dual Link, Quad HD, Quad split monitors, etc.
- Automatic equalization and re-clocking
- Supports all ancillary data, including embedded audio
- Reference via BNC, passive loop, PAL/NTSC color black or HD tri-sync
- 10/100/1000 Ethernet LAN
- Embedded Linux OS with internal webserver for web browser control
- HTTP Control
- Optional pushbutton remote control panel via Ethernet
- 1RU form factor for 16x16, 2 RU for 32x32
- Power loss recovery to the last operational state, both router and control panel.
- Redundant power supply (optional), isolated power inputs

KUMO Connections

Figure 1. KUMO Rear Panel Connections (3232 shown, other models similar)

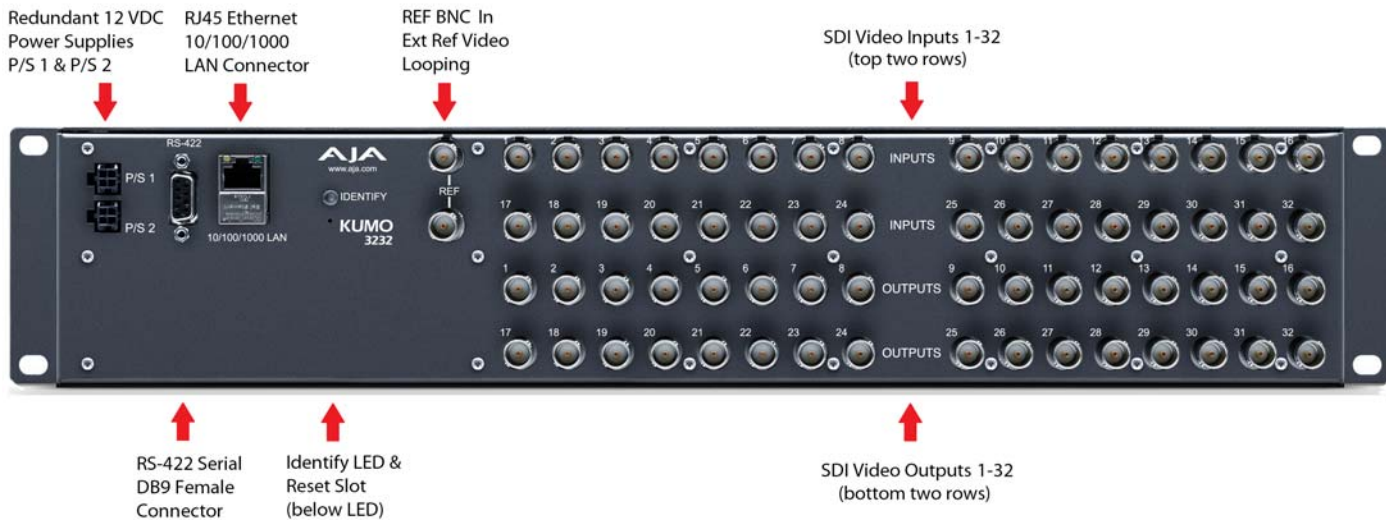

P/S 1 & P/S 2 Power Connectors

Power to the KUMO unit is supplied by a power supply brick that accepts a 110-220VAC, 50/60Hz power input and supplies +12 VDC to KUMO via connector P/S 1 or P/S 2. Only one power supply is required and may be connected to either of the two power connectors. An optional second power supply provides power redundancy to help protect against outages. If one power supply should fail, KUMO automatically switches over to the other power supply without signal interruption. For additional protection, connect the two supplies to different AC branch circuits so that KUMO will remain on even if there is a failure or open circuit breaker on one branch.

Power Loss Recovery If KUMO experiences a loss of power, when power is restored the router returns to the previous state of all source to destination crosspoints, and all configured source and destination names are retained. If a KUMO control panel configured with a KUMO router loses power, when power is restored the control panel's configuration is retained, and button tallies will return to their previous states.

RJ45 Ethernet Connector The RJ45 Ethernet connector allows you to connect KUMO to an Ethernet 10/100/1000 Ethernet LAN using CAT5 cable as explained in the section that follows. Multiple configurations are possible, including standalone control, a local LAN, or a WAN.

ID and Reset The ID LED lights when you use the web interface to identify the KUMO unit you are controlling. The Reset button (pinhole) below the LED allows a safeboot reset of the unit as explained in Chapter 3: ["Safeboot Reset" on page 41](#).

REF BNC connector The REF BNC connector is the looping input for synchronizing the switching timing of KUMO to your house video signals. Apply an analog NTSC, PAL, or Tri-level sync signal to this input. Also be sure to connect a terminator to the second connector, or if you loop from that connector to other equipment, be sure to terminate the connection at the other equipment.

When reference is present, Kumo will switch in vertical interval with respect to the reference input. If no reference is present, the Kumo will switch at random times.

Video Inputs and Outputs Depending on your KUMO model, up to 32 SDI (SMPTE 259/292/296/424) video inputs and outputs can be connected to the video input and output BNC connectors.

Normal mode In Normal mode, BNC inputs and outputs have a one-to-one relationship with the SDI signals being routed.

Dual and Quad modes In Dual mode, inputs and outputs use adjacent pairs of BNCs for each routed signal. In Quad mode, four adjacent BNCs are used for each routed signal

Table 1. Dual and Quad Mode BNC Connectors and Signals

Dual Mode				Quad Mode	
BNC #	Signal	BNC #	Signal	BNC #	Signal
1-2	1	17-18	9	1-4	1
3-4	2	19-20	10	5-8	2
5-6	3	21-22	11	9-12	3
7-8	4	23-24	12	13-16	4
9-10	5	25-26	13	17-20	5
11-12	6	27-28	14	21-24	6
13-14	7	29-30	15	25-28	7
15-16	8	31-32	16	29-32	8

RS-422 DB9 Connector

KUMO includes an RS-422 female DB9 connector for making serial connections to other equipment. This control connection enables interoperability with other devices, including those that use GVG Native Protocol.

Older Model RS-422 Adapter

Older KUMO routers (serial numbers ending in -R0) needed an RS-422 adapter for proper serial control operation. This adapter was shipped with those older model routers. Be aware of this fact if your facility has a mixture of older and newer KUMO routers that use RS-422 control.

Figure 2. RS-422 Adapter

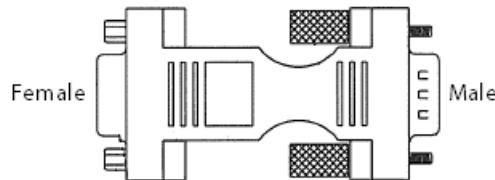

NOTE: Only KUMO routers with a serial number ending in -R0 require this adapter. KUMO routers with serial numbers ending in -R1 do NOT require the adapter.

KUMO Control and Monitoring

The KUMO router user-interface provides powerful remote setup, control, and monitoring with:

- Zero-configuration Bonjour Protocol and support for UPnP networking protocols
- Remote web browser control interface via Ethernet
- Optional push-button remote KUMO CP control panel for control of up to four KUMO routers
- GVG Native Protocol built-in to allow serial or LAN interconnection (one RS-422 or up to ten Ethernet) and interoperability with other equipment. Specifically, Kumo can be controlled by the SMS 7000 portion of the GVG Native Protocol. For details, refer to: *"GVG Native Protocol Support" on page 49*. Also refer to Grass Valley documentation at:

http://www.grassvalley.jp/pdf/RoutingProductsProtocolManual_2.pdf

Network Configuration Overview

KUMO's internal HTTP networking software supports three levels of network control:

- Closed KUMO network – uses Bonjour
- Auto Configured LAN – employs a Bonjour or UPnP enabled computer/browser to automatically connect devices and allows KUMO web browser User Interface (UI).
- Standard TCP-IP network – employs DHCP or Static IP addressing and allows the KUMO web-based UI and an unlimited number of KUMO routers and up to 16 KUMO CP control panels.

Direct Connection

In a direct connection, the control computer (Mac /PC) or a KUMO CP control panel connects to a KUMO router using an Ethernet cable (cat 5) between the RJ45 connectors on both devices.

Figure 3. KUMO Router Direct Connection to KUMO CP or Mac/PC

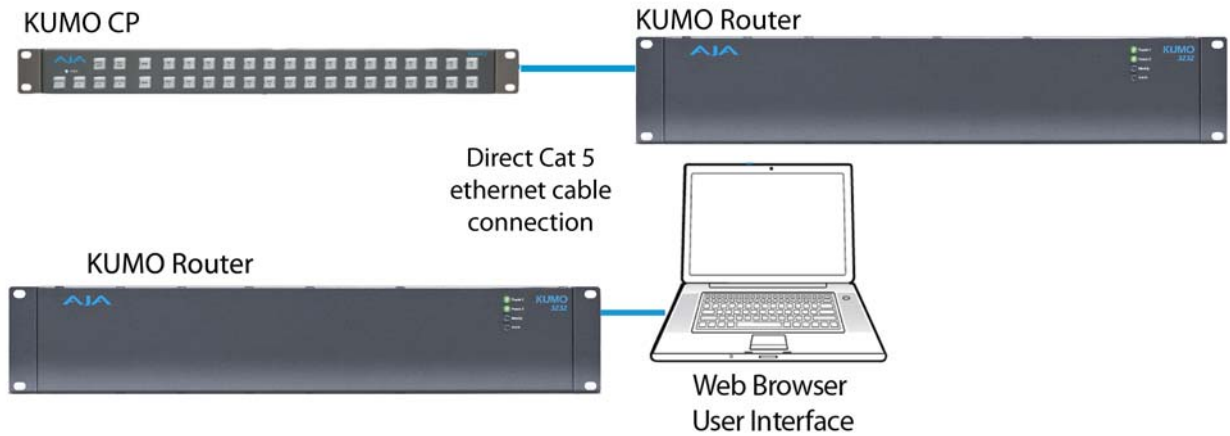

LAN Connection Using a Hub or Switch

In a LAN connection, one or more KUMO routers, KUMO control panels, and web browser equipped computers are connected to your LAN or closed network using Cat. 5 Ethernet cable and an Ethernet hub or switch.

Figure 4. KUMO LAN with Routers, Control Panels, and Web Browser UI

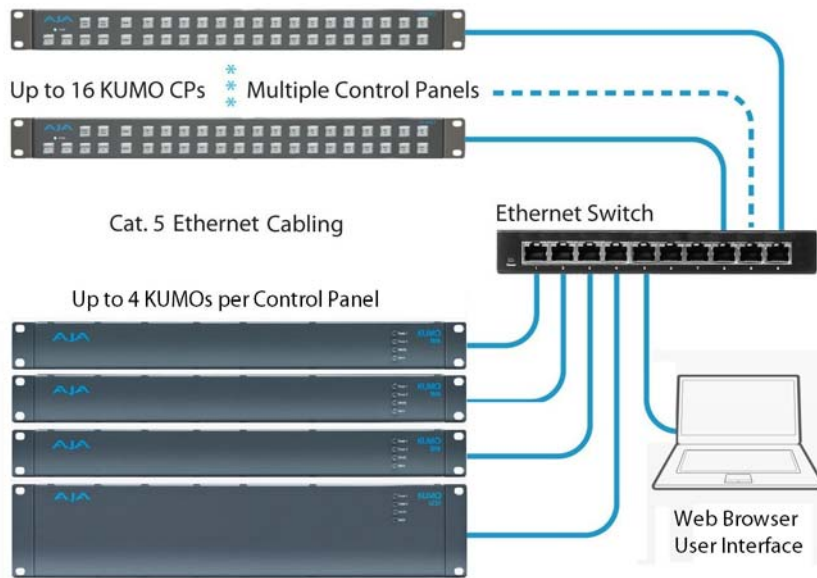

Default Network Settings

KUMO routers and control panels ship with DHCP enabled, making system operation possible simply by connecting the KUMO device's Ethernet cabling.

In addition, temporary default static IP addresses can be activated for initial KUMO system configuration. See ["KUMO Temporary Static IP Address" on page 16](#).

In This Manual

Chapter 1: Introduction lists features and gives a general description of the product.

Chapter 2: Installation details KUMO installation, connections, and networking configuration options (from closed to WAN (wide area) networking).

Chapter 3: Web Browser User Interface provides complete instructions for controlling and monitoring the KUMO router, from a computer.

Chapter 4: KUMO Remote Control Panel details the configuration and operation of the optional KUMO CP Control Panel.

Appendix A: Specifications lists technical specifications for the product.

Appendix B: Safety and Compliance information.

Index

Chapter 2: Installation



Introduction

KUMO SDI routers are easy to set up and use. All of the steps for KUMO installation and configuration are documented in this chapter, summarized as follows:

1. Install the chassis in an appropriate rack. If you are mounting multiple KUMO units, try to place them visually in the same area so if you communicate with them via a network attached computer, you can use the KUMO's Identify feature to flash the corresponding LED of the unit you're communicating with. Ensure you have an Ethernet cable routed to where the KUMO will be placed.
2. Assemble the Ethernet network connections to a closed network or LAN using Cat.5 Ethernet cable and any required switches and hubs.
3. Connect the KUMO to power, connecting the power cord to mains AC.
4. If necessary, configure device network settings for operation in your facility.
5. Cable the system SDI video source and destination equipment and reference signals.
6. If operating with or 4K signals, select the appropriate KUMO operating mode...

**Warning!**

Do not defeat the safety purpose of the grounding-type plug.

**Caution!**

To meet safety regulations for leakage current when using redundant power supplies, connect the KUMO dual power supplies to separate branch circuits.

What's In The Box?

When you unpack your AJA KUMO SDI router, you'll find the following components:

- KUMO Chassis or KUMO CP option
- AC adapter and AC power cord
- The manual you're reading (on CD)

Please save all packaging for shipping KUMO should you wish to do so when moving or sending it in for service

Figure 5. KUMO Shipping Box Contents

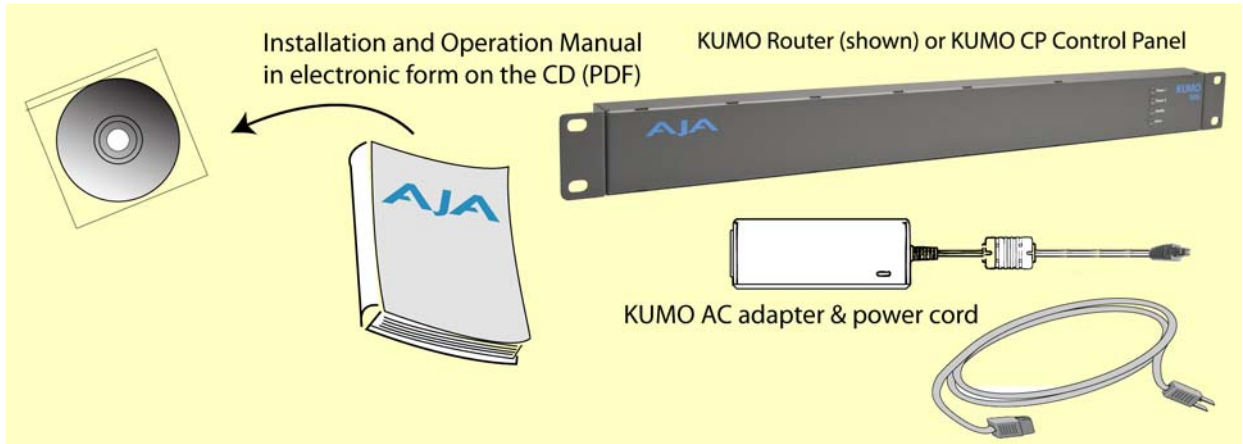

KUMO Chassis Installation

Where to Place KUMO

Plan adequate space for cable routing from the back of the router chassis. Ensure that SDI video cable connectors will not be stressed and that cables are not bent or crimped in the process.

When rack mounting or stacking multiple KUMO chassis, ensure there is adequate airspace for cooling around the KUMO units. Note the location of cooling vents on all equipment next to the KUMO and ensure none are obstructed.

Physical Requirements

When planning equipment locations and mounting methods, take into account the size of the router chassis:

- Router Dimensions:**
- 1 RU Height – 1.75" (4.45 cm); Depth – 1.5" (3.81 cm); Width – 19" (48.3 cm)
 - 2 RU Height – 3.47" (8.814 cm); Depth – 1.543" (3.92 cm); Width – 19" (48.3 cm)

Power Requirements

- Input Voltage: 110-220VAC, 50/60Hz to 12 VDC brick converter supply (fully redundant with optional second brick supply; AJA recommends AJA p/n 103147-00)
- Power Consumption: KUMO 1604 = 9 Watts; KUMO 1616 = 20 Watts; KUMO 3232 = 26.4 Watts



Caution!

KUMO is designed to take advantage of its chassis to aid in cooling. It is common and expected for the densely populated chassis to have a warm front panel in normal, active operating conditions.



Warning!

Do not open the chassis. There are no user-serviceable parts inside. Opening the chassis will void the warranty unless performed by an AJA service center or licensed facility. Remove the brick power supply AC line cord(s) from mains power when moving the unit.

Physical Equipment Setup

Before setting up the KUMO router(s) and KUMO CP panels, ensure you've got all equipment interconnected:

1. Connect power supplies (1 or 2 for redundancy) to KUMO routers and control panels.
2. Connect source and destination SDI equipment (this step can be deferred).
3. Connect network:
 - Direct Connection: connect a KUMO router to a KUMO CP (if used), or to a Mac or PC, via an Ethernet Cable.
 - LAN Connection: connect a KUMO router (and a KUMO CP if used) to a hub or switch and connect a PC or Mac to the same LAN via a hub or switch.

NOTE: KUMO devices are compatible with both CAT-5 straight-through and cross-over Ethernet cables—they automatically detect whichever is used.

4. Proceed to your desired network configuration method using one of the procedures presented later in the chapter.

Quick Start Configuration

Some simple methods of quickly configuring your KUMO system for fast operation are presented here. More detailed descriptions are presented later in this manual. We strongly recommend that you read the full KUMO Manual to get the most out of your system.

Default Auto Configure KUMO Router and CP

If you purchased a KUMO CP along with your KUMO router, the easiest way to get your system operating is to simply directly connect them with a single Ethernet cable and power up both units. The KUMO CP will use an Auto Configure function to set itself up to operate with the KUMO router it is directly connected to. The KUMO CP panel buttons will light and, if SDI BNC connections have been made, you will be able to route sources to destinations.

Figure 6. KUMO Router Direct Connection to KUMO CP

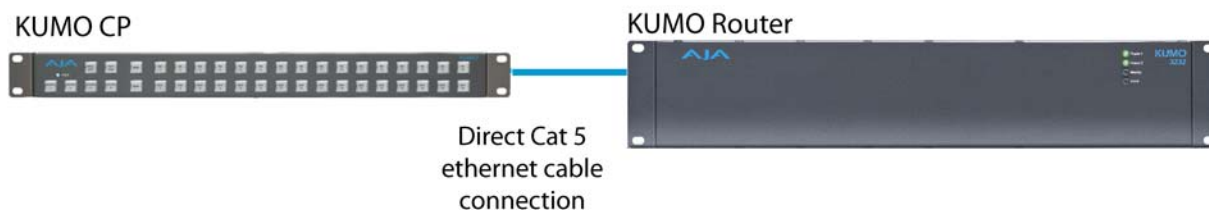

A KUMO CP that has had its network settings configured previously will not automatically find a directly connected KUMO router in this manner.

The Reset "Auto Configure control on the KUMO CP's Configuration webpage can be used to restore this capability. See "[Configuration Page](#)" on page 46.

DHCP on an Existing Network

Another easy way to get your KUMO system operating is to connect the KUMO Router and KUMO CP to an existing network configured with a DHCP server. When the units reset during power up, they will see the DHCP server and automatically be given

compatible IP network settings. If these are the only KUMO devices on the network, the KUMO CP should be able to control the KUMO router. In addition, if auto discovery is configured on a computer on that network, that computer will be able to find and control the KUMO router via a web browser (see below).

Computer Auto Discovery

Stand-alone KUMO operation described above works fine for some simple applications, but you will probably want to be able to operate your KUMO system with a computer, using a web browser UI, and have the KUMO reside on an existing network to permit control from different locations. AJA software updates, selecting operating modes, and choosing some other settings will also require a computer connection.

Computers can support network auto discovery, which makes the network configuration process easy. Two methods of connecting using this technique are described below.

Mac Configuration with Safari Browser Using Bonjour

The Mac OSX Safari browser has Bonjour built-in, which can be used to auto-detect and connect to a KUMO router. To do so:

1. Start Safari browser on a Macintosh connected to the KUMO network—ensure KUMO to be controlled is powered up and connected via Ethernet (directly or via LAN).
2. Click on the Bookmark icon (menu bar, far left) and select the Bonjour collection.

NOTE: If the Bonjour collection is not visible, go to Safari->Preferences->Bookmarks, go to the Bookmarks Collections section, and then check the "Include Bonjour" checkbox.

3. Double-click on the KUMO router or control panel in the Bookmarks pane.

NOTE: The KUMO name will be similar to: AJA KUMO1616-555 (where 1616 is the model number and -555 is the unit's serial #).

Figure 7. Safari Bonjour Bookmarks

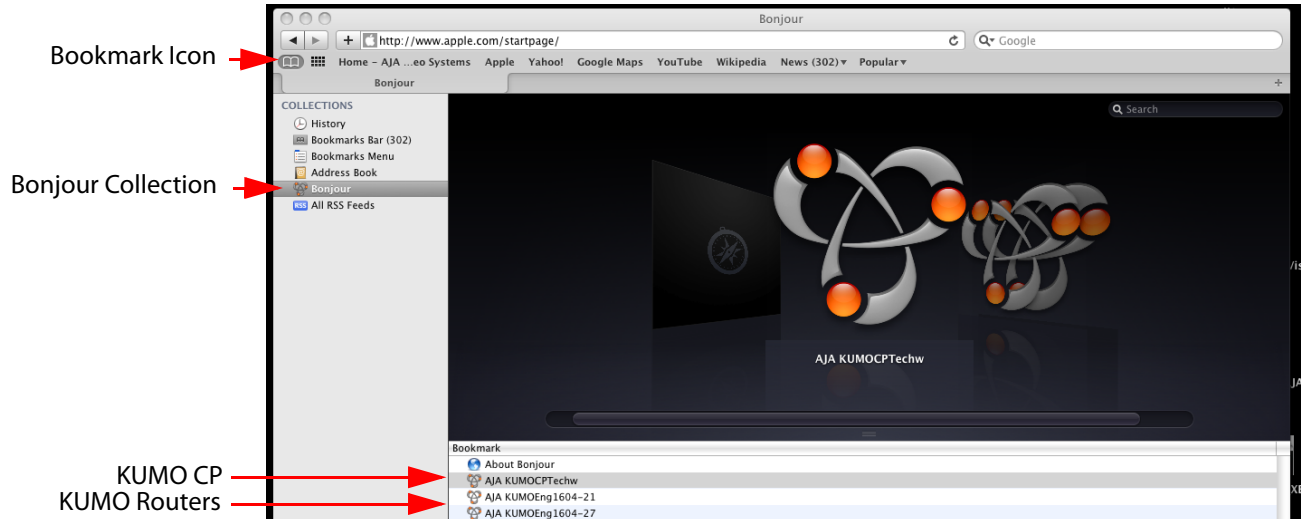

4. Safari will display the KUMO web user-interface, which you can use to control and configure that KUMO device.

Windows 7 PC Configuration using UPnP

If your Windows 7 PC supports UPnP protocols (most do) and UPnP service is enabled (refer to your Microsoft Windows documentation), you can control KUMO routers by simply selecting one from a device list:

1. Ensure KUMO to be controlled is powered up and connected via Ethernet (directly or via LAN).
2. Use your Windows 7 Control Panel to go to Network and Internet.
3. Select View Network computers and devices.

Figure 8. Windows Network and Internet Screen

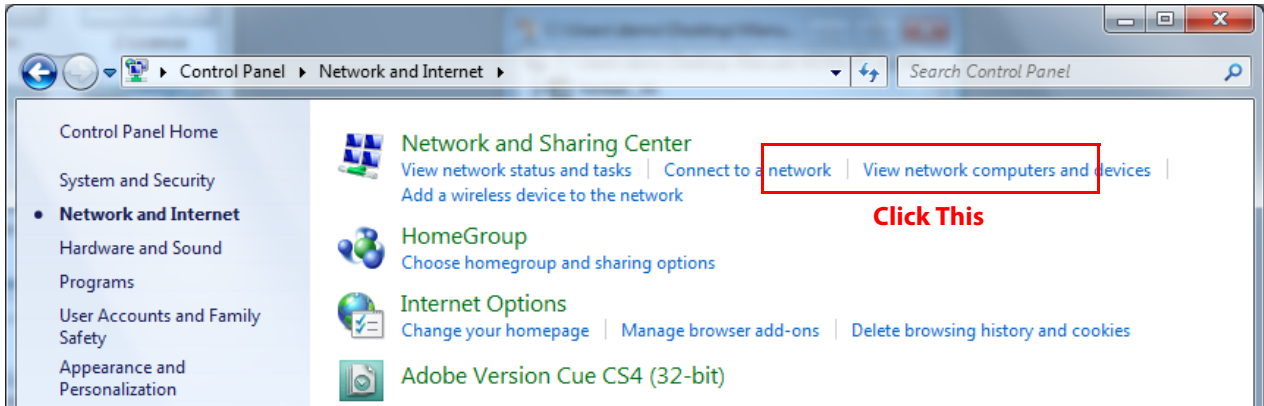

4. Look at the resulting device list under “Other Devices”—double click a KUMO’s name to launch your Window 7 PC’s default browser.

Figure 9. Windows Network Screen



5. The browser will display the KUMO web user-interface, which you can use to control and configure that KUMO device.

Other methods of KUMO network connection and configuration are described later in this chapter.

KUMO Temporary Static IP Address

KUMO devices also offer a factory default static IP address, allowing a direct and fail-safe way to connect via a computer connected to KUMO either directly or via a LAN connection. The computer you use will need to be set to a static IP address that is

compatible with the KUMO temporary IP address. Once connected, the KUMO device's network settings can be reconfigured to work with your facility network. The KUMO default static IP address is temporary and is intended only to allow an initial connection.

NOTE: All KUMO routers and control panels have the same temporary default IP address, so more than one device set to this default cannot reside on the same network simultaneously. Work with only one device at a time.

Table 2. KUMO Device Temporary Static IP Address Values

Device	IP address	Subnet Mask
KUMO Router and KUMO CP	192.168.101.1	255.255.255.0

NOTE: The default static address is temporary and will be disabled the next time KUMO restarts. Any changes in the Network configuration will be saved upon restart.

To set KUMO to its default static IP address:

1. Power up KUMO device and wait for it to boot normally.
2. Reset the KUMO device:
 - For a KUMO router, insert a straightened paper clip or similar device into the reset slot on the rear—hold for six seconds and then allow KUMO to restart. When the KUMO router default IP is set, the Identify LED will blink.
 - For a KUMO CP, press and hold the two SHIFT buttons on the panel for 5 seconds. When the KUMO CP default IP is set, the Source and Destination buttons will flash alternately.

Figure 10. KUMO Reset Slot Location



- IMPORTANT:** Be sure to record your computer's existing TCP-IP settings before the next step so that you can return the computer to normal operation after this procedure.
3. Configure your computer to 192.168.101.X. Do not use .1 at the end of the address to avoid duplicate IP addresses.

NOTE: Specific network reconfiguration procedures for Mac and PC are presented later in this chapter.

4. Start a web browser and enter 192.168.101.1 as the web address. This is the KUMO temporary static IP address.
5. Once you've connected using the static IP, you can then enter a desired network configuration using the KUMO device's Network tab.

Network Configuration Overview

A LAN is a shared network that includes other Ethernet devices all attached via a hub or digital switch. LANs may be divided into zones separated by software or hardware routers. Routers may also be used to connect the LAN to an outside wide area network (WAN) such as the internet. Devices on a LAN have IP addresses which may be fixed and permanent, or dynamically assigned by the network (DHCP with DNS server).

NOTE: Once connected and properly configured, KUMO can then be controlled by a web browser or one or more KUMO CP control panels. KUMO and KUMO CP are equipped with zeroconf (Bonjour) and support UPnP networking protocols but initially start up as DHCP active devices. If you are operating on a DHCP server, KUMO will take an assigned IP address and appear on the network.



Caution!

When attaching KUMO to a standard static IP LAN, you must configure KUMO components with a new, unique IP address. You should first talk to your network administrator and find out how it should be connected (TCP/IP Static IP or DHCP). Your IT department will be able to supply the information you need to install KUMO on a LAN.

KUMO uses TCP-IP network communications and Ethernet connections (a 10/100/1000 Ethernet port) for crosspoint control, status monitoring, and software updates. KUMO devices have an internal HTTP webserver that works with a standard web browser on a Mac or PC. An Ethernet cable can also be used to connect an optional KUMO CP (control panel) directly to a KUMO router for operation without a computer.

KUMO devices are compatible with both CAT-5 straight-through and cross-over Ethernet cables—they automatically detect whichever is used.

KUMO's internal HTTP networking software supports three levels of network control:

- Closed KUMO network – uses Default Auto Configure (KUMO CP), or Bonjour (Mac or PC).
- Auto Configured LAN – employs a Bonjour or UPnP enabled computer/browser to automatically connect devices and allows KUMO web browser User Interface (UI).
- Standard TCP-IP network – employs DHCP or Static IP addressing and allows the KUMO web-based UI and an unlimited number of KUMO routers and up to 16 KUMO CP control panels.

The following web browsers have been tested and approved for use with KUMO (Bonjour capability is recommended):

- Firefox - latest version on all platforms
- Safari - latest version MAC and Windows
- IE 7/8 - latest versions Windows
- Chrome - latest version on all platforms (Bonjour is supported, but DNSSD as a discovery tool is not available for Chrome)

Bonjour software is built into Apple Macs with OS X from version 10.2 onward and can be installed onto Windows PC computers. Bonjour for Windows adds zero-configuration capabilities to Internet Explorer and (with the DNSSD plug-in) to Firefox.

Once connected, you can use a web browser to:

- Configure any TCP/IP settings

- Select and name KUMO routers and control panels
- Assign a KUMO panel to be able to control specific KUMO routers
- Name sources and destinations
- Make Source to Destination assignments (signal routing)
- Change router operating mode (SDI, 2K, 4K)
- Set a variety of operational and monitoring options

Direct Connection

In a direct connection, you simply connect the control computer (Mac /PC) or a KUMO CP control panel to a KUMO router using an Ethernet cable (cat 5) between the RJ45 connectors on both devices.

Figure 11. KUMO Direct Connection to Mac/PC Web Browser or KUMO CP to KUMO

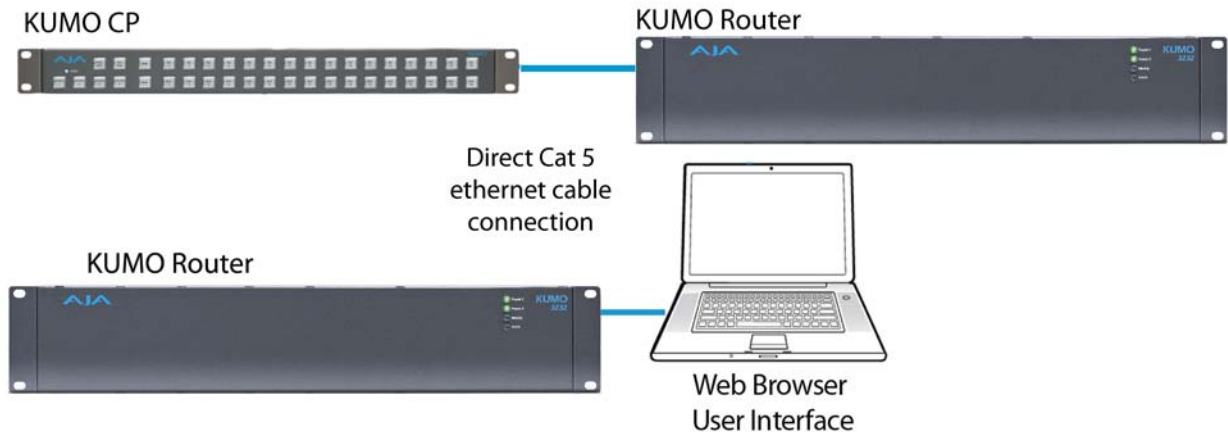

The KUMO CP Auto Configure assigns Router Select Button 1 to the attached router.

LAN Connection Using a Hub or Switch

In a LAN connection, connect one or more KUMO routers to your LAN or closed network using Cat. 5 Ethernet cable and an Ethernet hub or switch; then power up the equipment.

Figure 12. KUMO LAN with Web Browser UI

LAN-only system - use TCP/IP to configure routers and devices

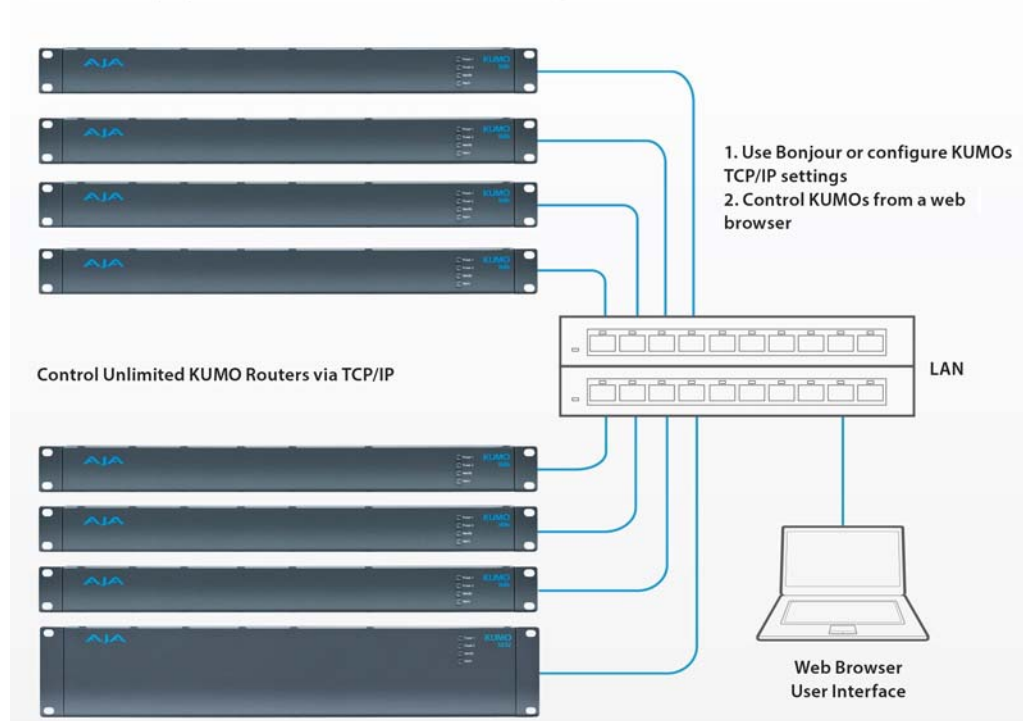

Setup and Control Methods

Regardless of direct connection or LAN connection, KUMOs are controlled over a network by connecting to KUMO's internal webserver with a standard web browser on a Mac or PC. To do this you first need to establish a network connection between the computer and the KUMO to be controlled. There are various methods supported for doing this depending on the operating system and/or web browser being used. Choose one of the following quick-start procedures that best fits your environment; each procedure is presented in step-by-step form later on these pages.

Mac OSX:

- Setup and Control from a Safari Browser on Mac OSX using Bonjour
- Setup and Control from a Browser on Mac OSX using a Static IP Address

Windows 7:

- Setup and Control from a Browser on Windows 7 using UPnP
- Setup and Control from a Firefox Browser on Windows 7 using Bonjour
- Setup and Control from a Browser on Windows 7 using a Static IP Address

Windows XP:

- Setup and Control from a Browser on Windows XP using UPnP
- Setup and Control from a Firefox Browser on Windows XP using Bonjour
- Setup and Control from a Browser on Windows XP using a Static IP Address

All of the above methods are explained on the following pages. Select the method that works the best for you and your environment.

IMPORTANT: When using KUMO in a DHCP or Static IP addressed network, it is best to select and maintain a consistent network scheme. If you use a mix of DHCP and Static IP addresses, inconsistent performance can result. The most stable operation is achieved when all IP addressing is either DHCP or Static

Setup and Control from a Browser on Mac OSX

The two easiest methods to set up and control a KUMO router system from a Mac are:

- Setup and Control from a Safari Browser on Mac OSX using Bonjour
- Setup and Control from a Browser on Mac OSX using a Static IP Address

Safari Browser Using Bonjour

This method was covered earlier in this chapter. See [“Mac Configuration with Safari Browser Using Bonjour” on page 15.](#)

Safari Browser: Type in KUMO Static IP Address

KUMO offers a factory default static IP address. The default static IP address is temporary and is intended only to allow an initial connection. Once you’ve connected using the static IP, you can then enter a desired network configuration using KUMO’s Network tab.

NOTE: *The default static address is temporary and will be disabled the next time KUMO restarts. Any changes in the Network configuration will be saved upon restart.*

1. Set the KUMO to its factory default IP address. See [“KUMO Temporary Static IP Address” on page 16](#) for this procedure.
2. Configure your computer to talk on the 192.168.101.X subnet as shown below:

IMPORTANT: First record existing TCP-IP settings so that you can return your computer to normal operation after this procedure.

- A. Go to your System Preferences>Network and select Ethernet and Configure: Manually.

Figure 13. Mac Network Setup Screen (System Preferences -> Network)

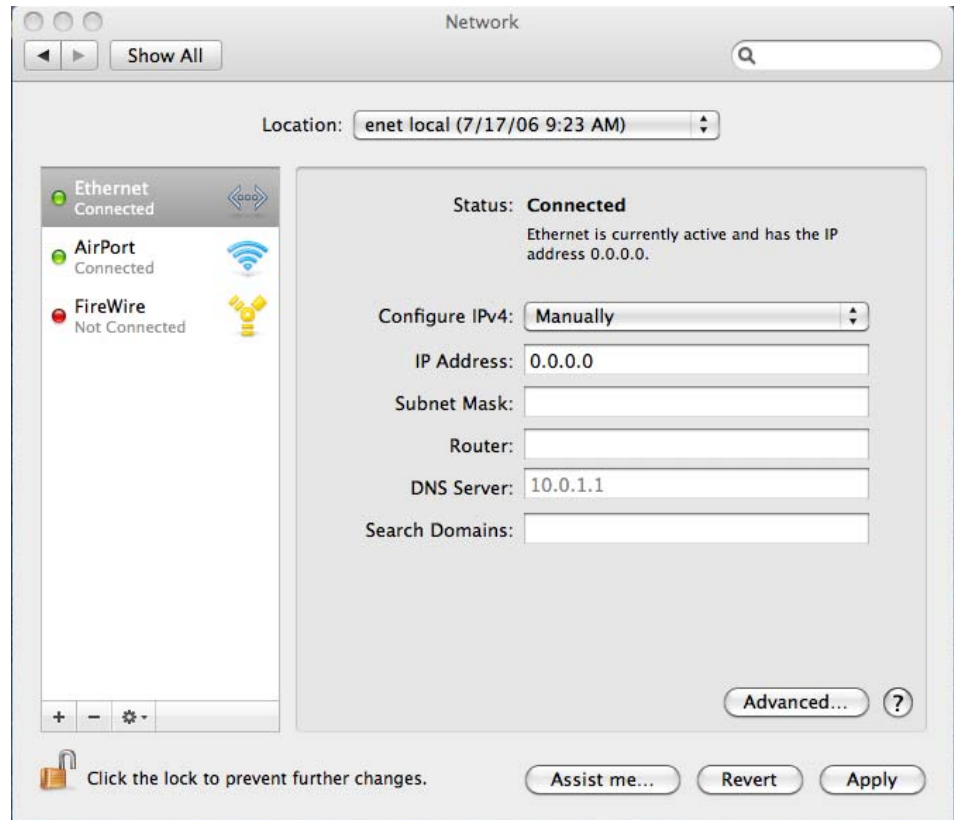

- B. Input the address information shown below:
 - IP Address: 192.168.101.X (do not use .1 in the last octet).
 - Subnet Mask: 255.255.255.0
- C. Click Apply.
3. Ensure the KUMO device to be controlled is connected to the Mac via Ethernet (directly or via LAN).
4. Start Safari and enter 192.168.101.1 as the web address. This is the KUMO temporary static IP address.
5. Once you've connected using the static IP, you can then enter a desired network configuration using the KUMO device's Network tab.
6. Restore your computer to its normal network settings using this procedure and the IP addresses you recorded earlier.

Setup and Control from a Browser on Windows 7

The easiest methods of setting up a controlling a KUMO device from a PC running Windows 7 are:

- Setup and Control from a Browser on Windows 7 using UPnP
- Setup and Control from a Firefox Browser on Windows 7 using Bonjour
- Setup and Control from a Browser on Windows 7 using a Static IP Address

Windows 7: Using UPnP (Universal Plug and Play)

This method was covered earlier in this chapter. See [“Windows 7 PC Configuration using UPnP” on page 16.](#)

Windows 7: Firefox Using Bonjour

Using Bonjour with Windows 7 and the Firefox browser requires the Apple Bonjour Print Services for Windows software and the DNSSD for Firefox add-on software.

NOTE: If you have iTunes running on your PC the Apple Bonjour software will already be installed.

Install Apple Bonjour Print Services for Windows

If necessary download and install the Apple Bonjour software.

1. The Apple Bonjour Print Services for Windows software can be downloaded from: <http://support.apple.com/kb/DL999>

Figure 14. Apple Bonjour Download Website

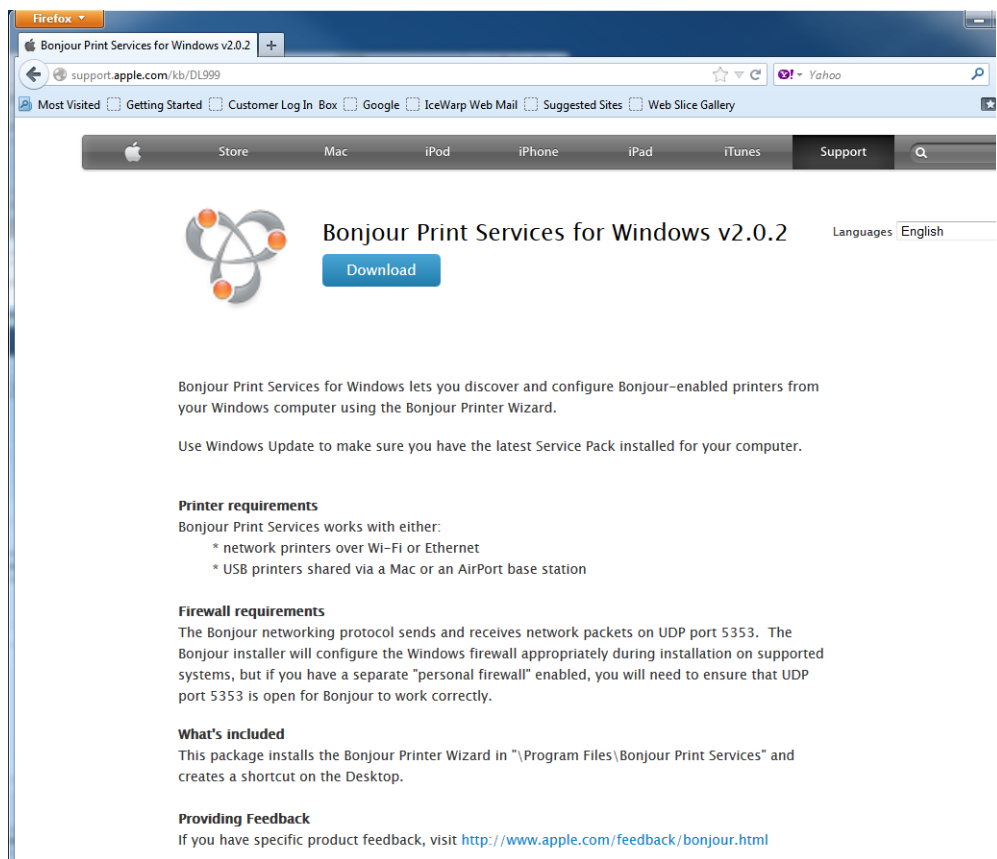

2. Click on **Download** and then save and run the download. Follow the installation instructions.

Figure 15. Bonjour Print Services Installation Screen



Install DNSSD for Firefox Add-On

With Apple Bonjour installed, download and install the DNSSD for Firefox add-on:

1. The Firefox add-on software can be downloaded from:
dnssd.me

Figure 16. DNSSD Website

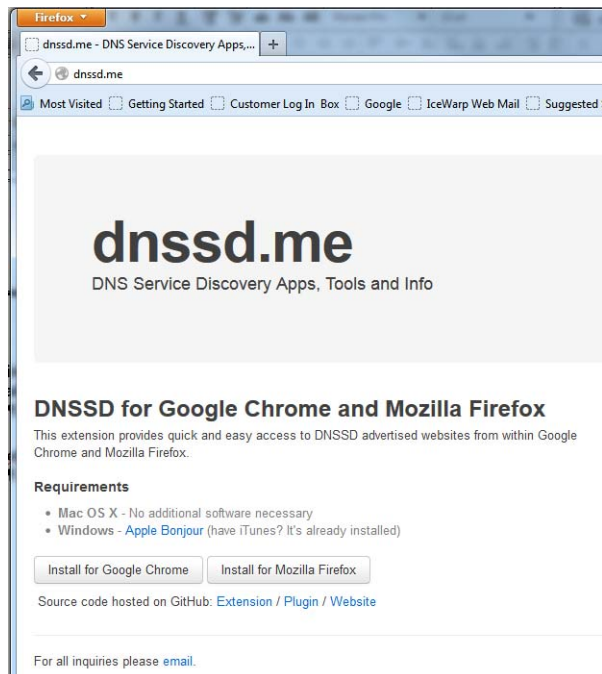

2. Click on **Install for Mozilla Firefox** to go to the Firefox Add-Ons webpage:

Figure 17. Firefox Add-Ons Webpage

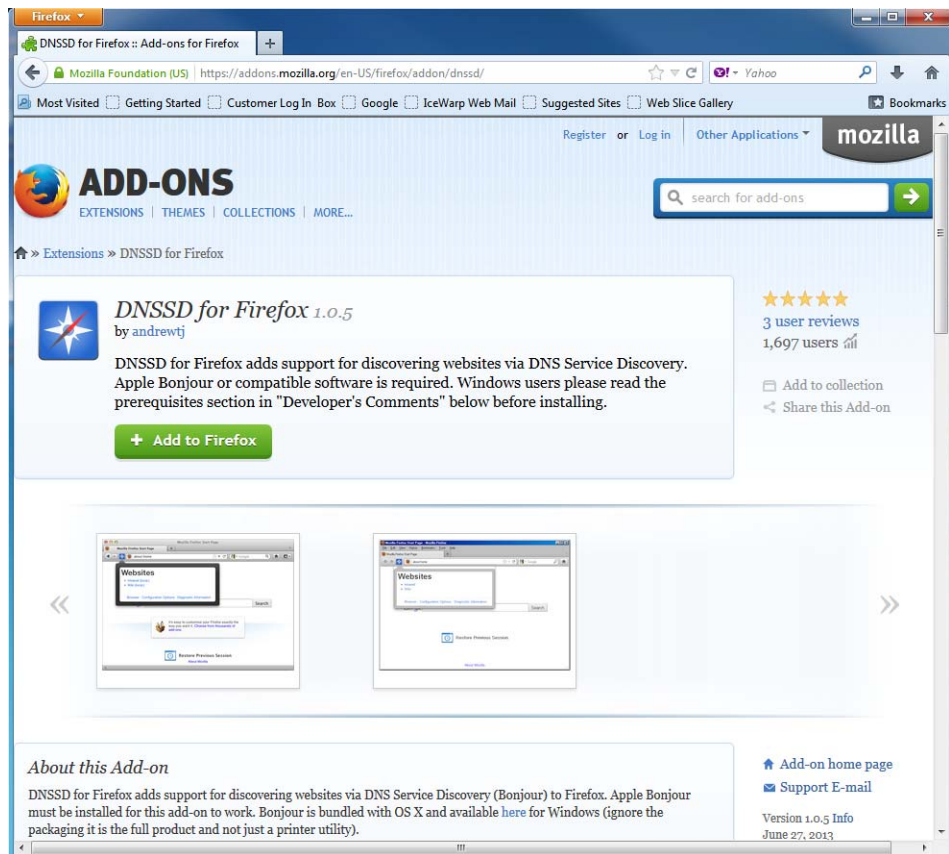

3. Click on **Add to Firefox**, follow the installation instructions, and restart Firefox.
4. The DNSSD icon should now appear on the Firefox Navigation toolbar.

Figure 18. DNSSD Icon



NOTE: If the DNSSD icon is NOT displayed in the Firefox Navigation toolbar, do the following:

- A. If the menu bar is not displayed, click on the Firefox name at the top left of the screen, then click on Options, and activate the Menu Bar.
- B. Click on View>Toolbars>Customize.
- C. Locate the DNSSD icon and drag it to your preferred Firefox toolbar location.

Accessing KUMO Devices in Firefox

1. Click on the DNSSD icon to open a drop-down list of all the KUMO devices accessible on the network.

Figure 19. Firefox DNSSD list of KUMO Devices

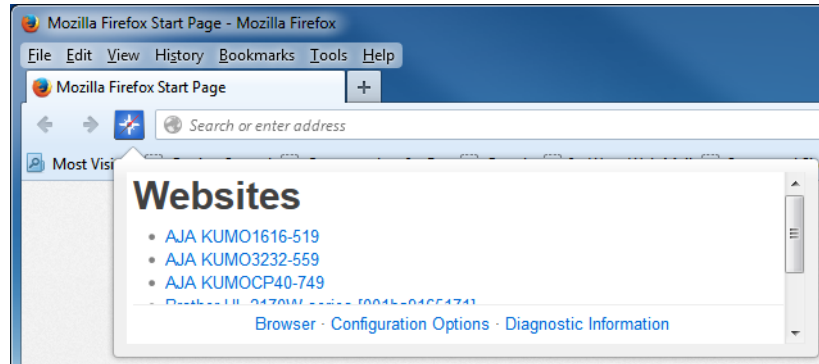

2. Click on a KUMO device's name to open its webpage.
3. Once connected to KUMO's web interface, reconfigure KUMO's network parameters as desired.

Windows 7 Browser: Type in KUMO Static IP Address

KUMO offers a factory default static IP address. The default static IP address is temporary and is intended only to allow an initial connection. Once you've connected using the static IP, you can then enter a desired network configuration using KUMO's Network tab.

NOTE: *The default static address is temporary and will be disabled the next time KUMO restarts. Any changes in the Network configuration will be saved upon restart.*

1. Set the KUMO to its factory default IP address. See "[KUMO Temporary Static IP Address](#)" on page 16 for this procedure.
2. Configure your computer to 192.168.101.X as shown below (this example is for a PC connected directly to KUMO):

IMPORTANT: First record existing TCP-IP settings so that you can return your computer to normal operation after this procedure.

- A. Use Control Panel to access your Local Area Network properties. In Windows 7 the path is:
 - Control Panel > Network and Internet > Network and Sharing Center
- B. Then, under "Connections" click on the Local Area Connection for the PC's Ethernet port.

Figure 20. Windows Network Configuration Screens

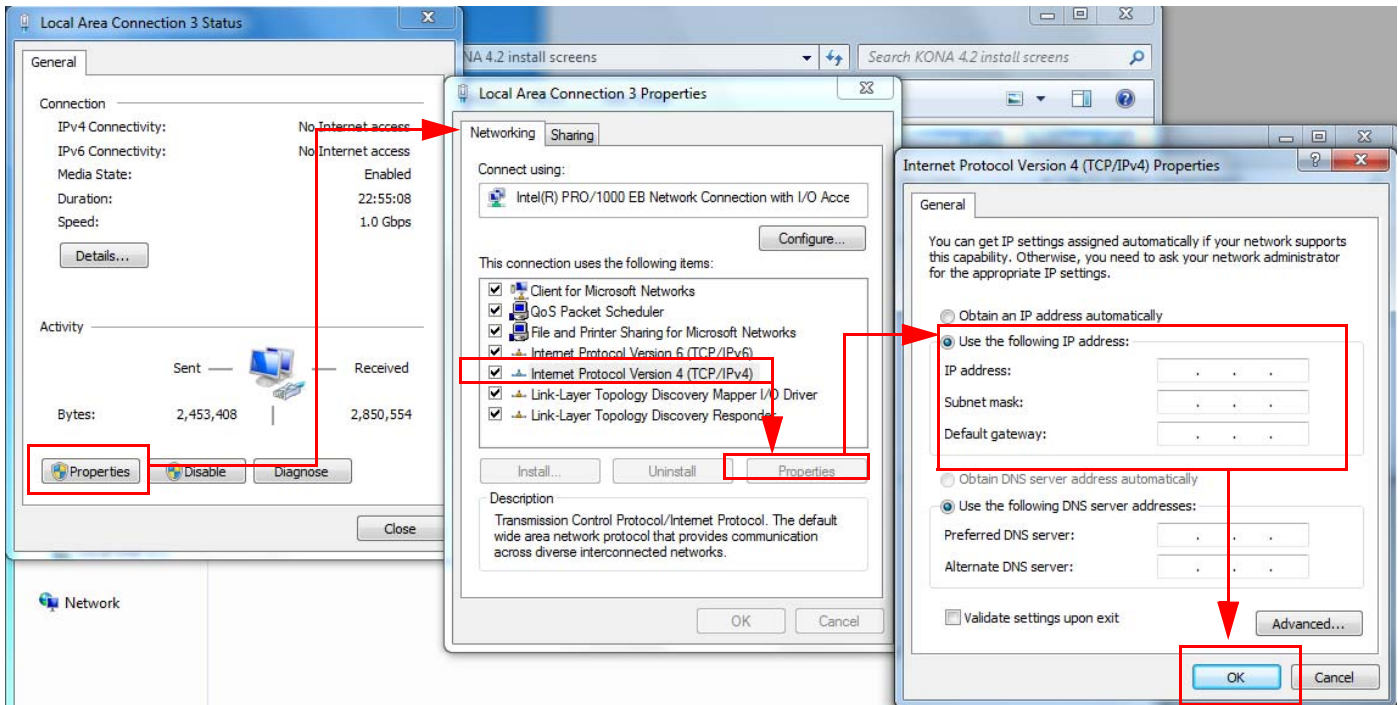
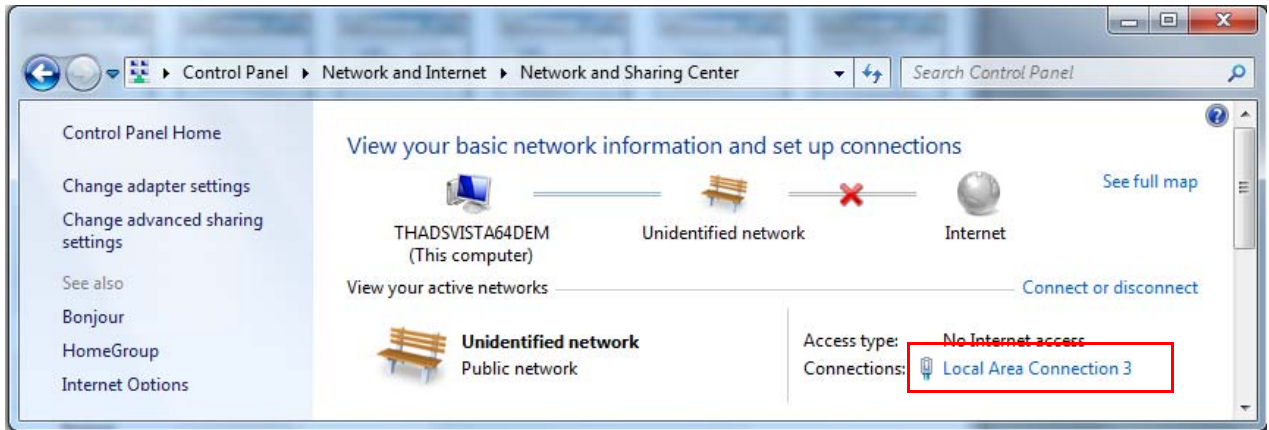

- C. In the resulting General dialog screen, select the Properties button.
- D. Then on the Networking tab, select Internet Protocol Version 4 and click the Properties button below.
- E. Finally, click the “Use the following IP address:” radio button and enter the IP Address and Subnet Mask below:
 - IP Address: 192.168.101.X (do not use .1 in the last octet).
 - Subnet Mask: 255.255.255.0
- F. Click the OK button to store the changes.

NOTE: The previous step is temporary. You will later need to restore the original settings on your computer.

- 3. Connect the Windows 7 PC to KUMO's RJ-45 port (either direct or through your LAN)

4. Point your web browser to 192.168.101.1 as the web address. This is the KUMO temporary static IP address.
5. Once connected to KUMO's web interface, reconfigure KUMO's network parameters as desired.
6. Restore your computer to its normal network settings using this procedure and the IP addresses you recorded earlier.

Setup and Control from a Browser on Windows XP

The easiest methods of setting up and controlling a KUMO router from a PC running Windows XP are:

- Setup and Control from a Browser on Windows XP using UPnP
- Setup and Control from a Firefox Browser on Windows XP using Bonjour
- Setup and Control from a Browser on Windows XP using a Static IP Address

Windows XP using UPnP (Universal Plug and Play)

Windows XP PCs support UPnP protocols, though very often UPnP service is disabled as a default. (The procedure to enable UPnP is given later in this topic.) If UPnP is enabled, you can control KUMO routers by simply going to "My Network Places" and double-clicking on the KUMO as follows:

1. Ensure KUMO to be controlled is powered up and connected via Ethernet (directly or via LAN) to the Windows XP PC.
2. Go to Start > My Network Places.
3. Locate the Icon for the KUMO being controlled and double-click it.

Figure 21. Windows My Network Places Screen

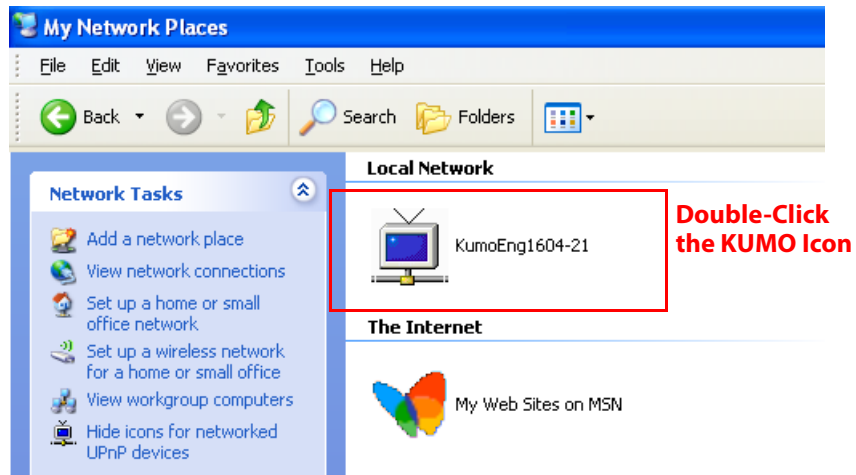

4. Double clicking a KUMO's icon launches your Window XP PC's default browser. The browser will display the KUMO web interface. Use it to control KUMO.

If you don't see a KUMO icon under "Local Network" on My Network Places, ensure there is either a direct connection or LAN connection and the KUMO is powered up. With those requirements satisfied, if no icon can be seen, then likely the UPnP services are disabled.

Enabling UPnP Services in Windows XP

1. Go to Start > Control Panel, and then click Add or Remove Programs.

2. In the Add or Remove Programs dialog box, click Add/Remove Windows Components.

Figure 22. Windows Add or Remove Programs Screen

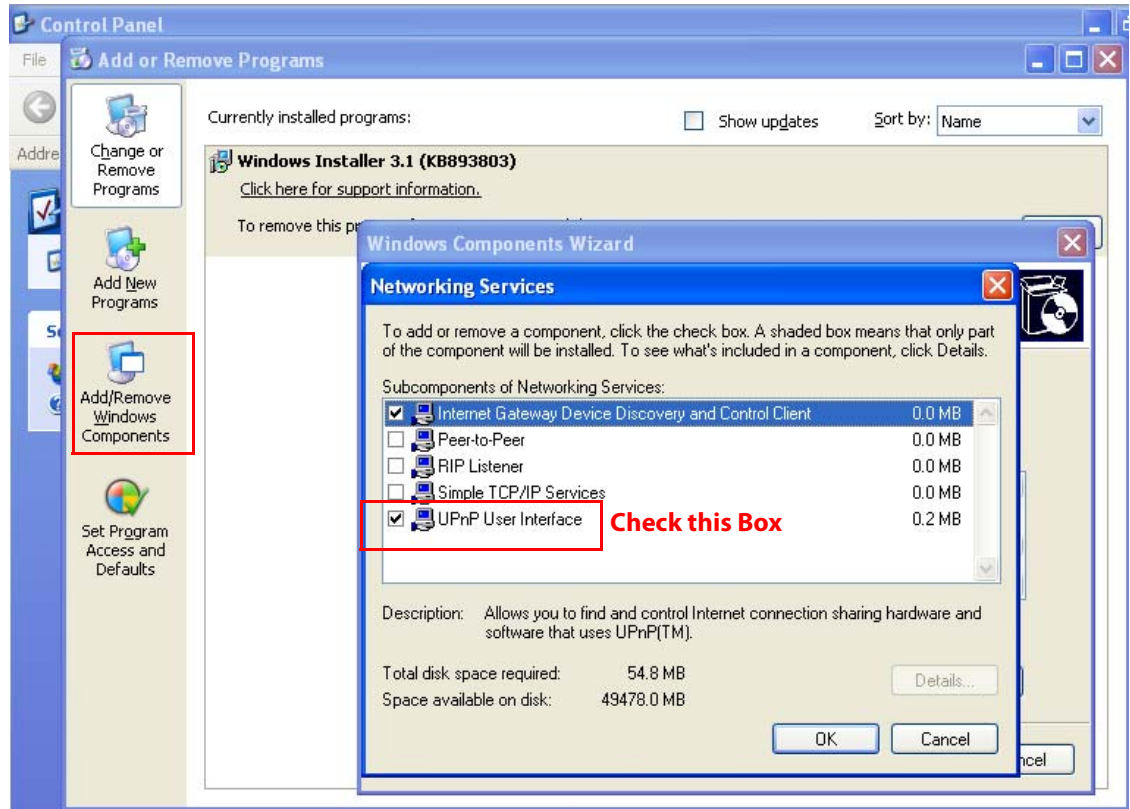

3. In the Windows Components Wizard, click Networking Services and then click the Details button below. You'll see a Networking Services dialog: locate the UPnP User Interface checkbox and click in it to check the box and enable UPnP service.
4. Click the OK button and then click Next in the Windows Components Wizard. You may need to provide your Windows XP installation CD.
5. Go to Start > My Network Places again and look for the KUMO icon as shown previously. UPnP devices on your local network will be displayed there, including KUMO. Whenever a KUMO is connected, a notifying icon will appear briefly in the System Tray. When you see the icon, go to My Network Places to find the KUMO icon and double-click it to launch KUMO's web interface for control and setup.

Windows XP: Firefox Using Bonjour

The Windows XP configuration required for using Bonjour with Firefox is the same as that used for Windows 7. See ["Windows 7: Firefox Using Bonjour" on page 23](#).

Windows XP Browser: Type in KUMO Static IP Address

KUMO offers a factory default static IP address. The default static IP address is temporary and is intended only to allow an initial connection. Once you've connected using the static IP, you can then enter a desired network configuration using KUMO's Network tab.

NOTE: The default static address is temporary and will be disabled the next time KUMO restarts. Any changes in the Network configuration will be saved upon restart.

1. Set the KUMO to its factory default IP address. See [“KUMO Temporary Static IP Address” on page 16](#) for this procedure.
2. Configure your computer to talk on the 192.168.101.X subnet as shown below (this example is for a PC connected directly to KUMO):

IMPORTANT: First record existing TCP-IP settings so that you can return your computer to normal operation after this procedure.

- A. Use Control Panel to access your Local Area Network properties. In Windows XP the path is:
 - Start > Control Panel > Network and Internet Connections > Network Connections
- B. Then, under “Network Connections” locate and click on the Local Area Connection for the PC’s Ethernet port.

Figure 23. Windows Network Configuration Screen

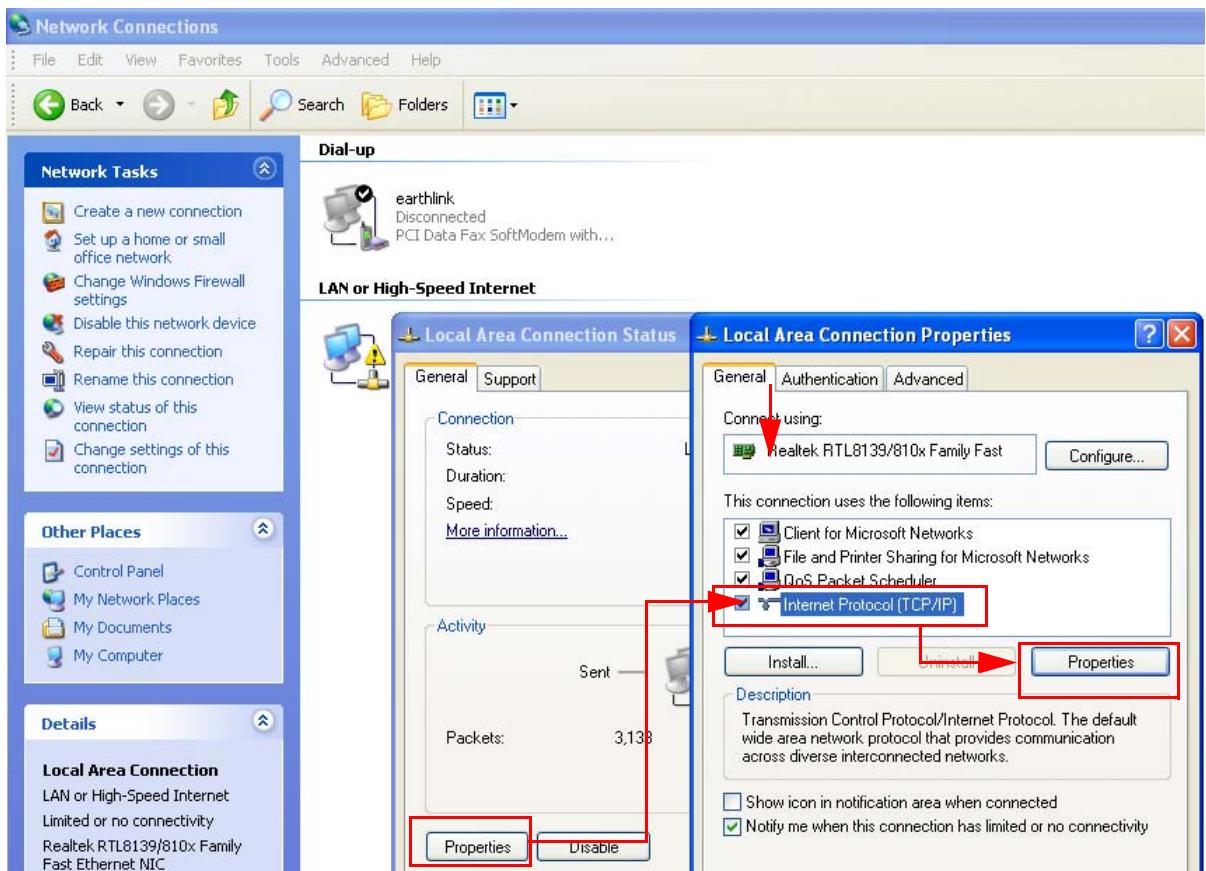

- C. In the resulting General dialog screen, select the Properties button.
- D. Then on the Local Area Connection Properties dialog, select the Internet Protocol item and click the Properties button below it.

Figure 24. Windows TCP/IP Properties Screen

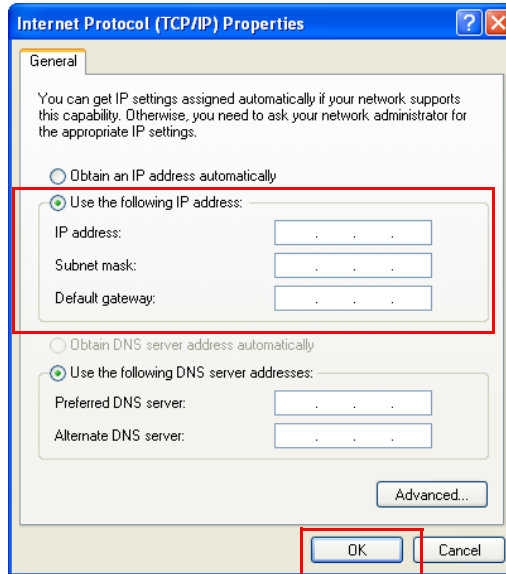

E. Finally, click the “Use the following IP address:” radio button and enter the IP Address and Subnet Mask below:

- IP Address: 192.168.101.X (do not use .1 in the last octet).
- Subnet Mask: 255.255.255.0

F. Click the OK button to store the changes.

NOTE: The previous step is temporary. You will later need to restore the original settings on your computer.

3. Connect the Windows XP PC to KUMO's RJ-45 port (either direct or through your LAN)
4. Point your web browser to 192.168.101.1 as the web address. These are the KUMO temporary static IP addresses.
5. Once connected to KUMO's web interface, reconfigure KUMO's network parameters as desired.
6. Restore your computer to its normal network settings using this procedure and the IP addresses you recorded earlier.

Larger System Control Configurations

This section describes a KUMO system network configuration that is part of a large LAN/WAN – TCP-IP networking (DHCP or Static IP), and any number or combination of KUMO routers, KUMO control panels, and web browser computer control.

If the KUMO will be attached to a WAN, talk to your IT administrator and obtain the details on how he/she wishes you to configure the KUMO (DHCP or static IP). Manually connecting to a network, you will need to configure the KUMO IP CONFIG, IP ADDR, IP MASK, and IP GATEWAY parameters according to the information obtained from your IT administrator.

Figure 25. KUMO and KUMO CP with Web Browser UI Control.

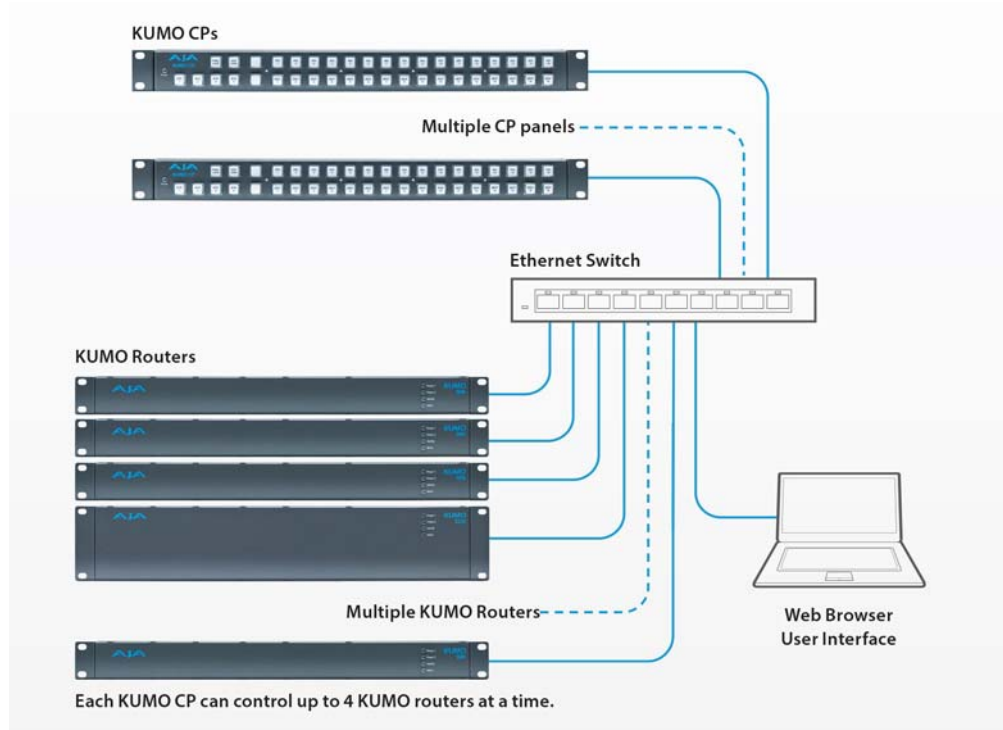

TCP-IP Network Connection

KUMO supports traditional TCP-IP networking through DHCP or Static IP addressing.

IMPORTANT: When using KUMO in a DHCP or Static IP addressed network, it is best to select and maintain a consistent network scheme. If a mixture of DHCP and Static IP addresses are used, inconsistent performance can result. The most stable operation is achieved when all IP addressing is either DHCP or Static.

Default DHCP Configuration

DHCP is the default initial configuration routine for KUMO devices. If you start up on a DHCP network, KUMO will accept assigned IP addresses. After DHCP initialization, use your zeroconf browser to view the KUMO webpage and view the assigned IP address.

Static IP Configuration

If your IT administrator prefers an assigned IP address that is fixed (called a "Static IP"), you will need to set network parameters using the KUMO UI Network page where you will enter:

- IP address type—Static IP
- a unique IP address
- the Subnet Mask and default gateway IP address (your LAN's internet router)

Figure 26. KUMO User Interface Network Tab

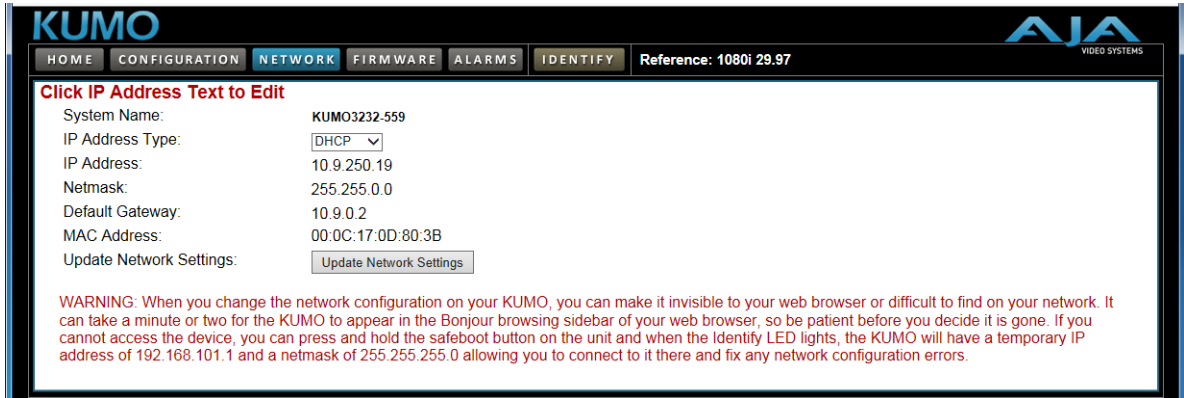

Select KUMO to Control from Webpage

With multiple KUMO routers on the same network, you can quickly select which router to control from the webpage. From the Home screen, use the pulldown menu in the upper left to see all of the KUMO routers present on the local LAN and select the one you want to control or monitor.

Figure 27. KUMO Router Selection



Assign KUMO CP to Control KUMO Routers

With multiple KUMO routers and KUMO CPs on the same network, you can assign which routers are able to be controlled by a panel by configuring the four Router Select buttons on the panel.

On the KUMO CP webpage, go to the Home page, click on the box below the RTR button, and select the KUMO router from the drop-down list.

Figure 28. KUMO CP Router Button Assignment

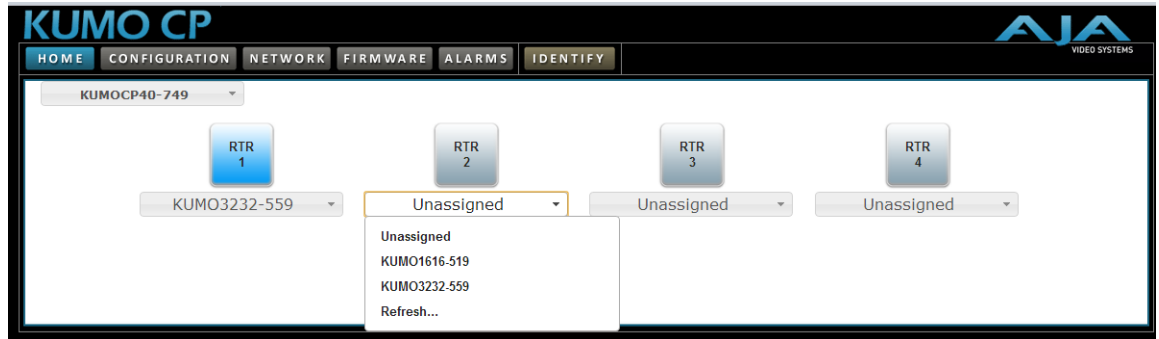

Chapter 3: KUMO Router Web Browser User Interface



Introduction

An optimized web server inside the KUMO allows you to remotely monitor and adjust parameter settings via a network-attached computer running a web browser. The network can be a closed local area network, a straight computer-to-KUMO Ethernet cable, or even exposed through a firewall to a broadband WAN (not generally recommended since anyone on the internet can then access the KUMO). The LAN connection on the KUMO uses a standard RJ45 connector, and communicates via standard “straight-through” CAT 5 Ethernet cables or null-modem (cross-over) cables without any configuration or strapping required.

NOTE: In this chapter a KUMO 3232 is used as the example. Other models will have fewer buttons.

Navigation Bar Information

The KUMO web browser user interface (UI) provides a navigational bar of tabs for access to five control screens and the Identify toggle button:

- Home – control panel for source/destination selections
- Configuration – custom naming for sources and destinations, and mode selection
- Network – IP settings for LAN/WAN operation
- Firmware – update menu for KUMO software from AJA
- Alarms – log of service failures and allows alarms to be suppressed
- Identify – toggles activation of Identify LEDs for easy location of various system components

Figure 29. KUMO Navigation Bar



Click any of the first five tabs to jump to that screen. To the right of the Identify button you will see the format of the Reference Video signal being used (if present).

KUMO Home

From the Home screen, you can use the pulldown menu in the upper left to see all of the KUMO routers present on the local LAN and select the one you want to control or monitor.

Control Panel Operation

Immediately below the KUMO selection menu are the Source (input) buttons. Below the Source (input) buttons are the Destination (output) buttons. Click on any Destination and it will highlight and cause its currently selected Source button to illuminate.

Figure 30. KUMO Web Browser Control Panel



NOTE: In Configuration, you can hide Destination buttons that are not wanted for control from your location (see "Hide" on page 38).

Router Configuration

From the Configuration screen you can select the operating mode (Normal, Dual, Quad), change the Source and Destination names and the colors of the buttons, and Lock and Hide Destination buttons.

Figure 31. KUMO Web Interface, I/O Configuration Screen

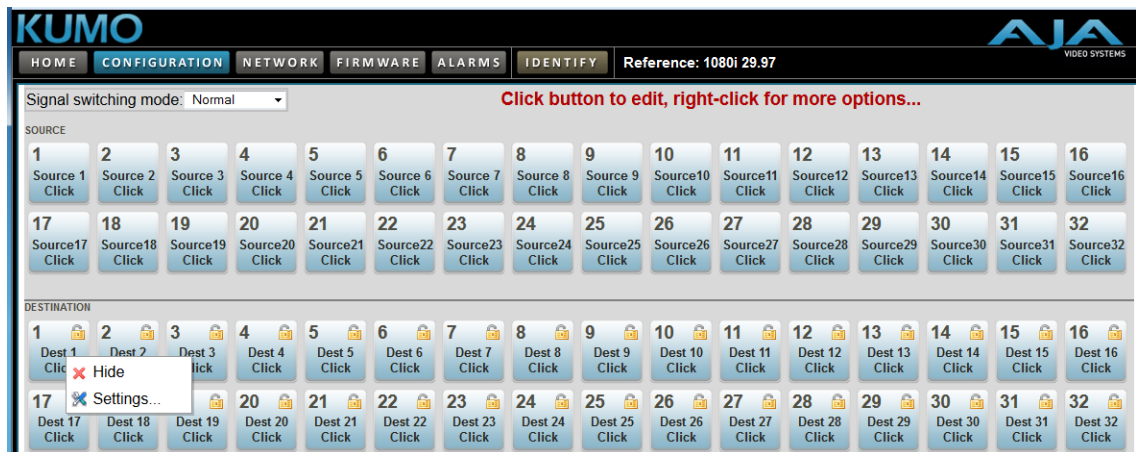

Mode Selection

Click on the **Signal switching mode** drop down list to select Normal, Dual, or Quad operating mode. When Dual or Quad mode is selected, the number of Source and Destination buttons will be reduced to match that configuration.

Figure 32. Dual and Quad Mode Reduced Sources and Destinations

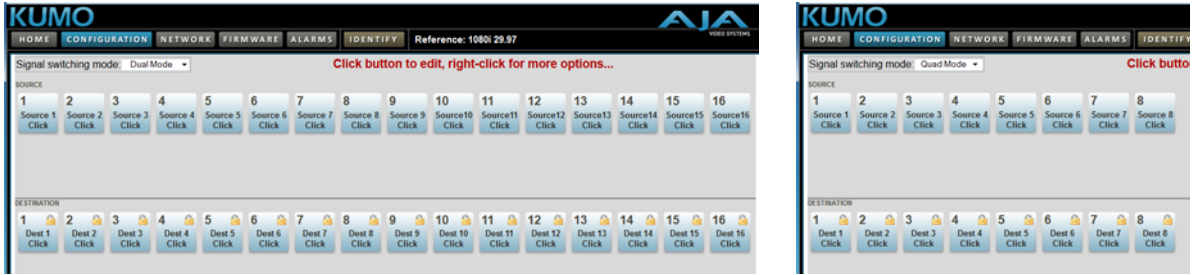

In Dual and Quad modes adjacent BNCs are used for each routed signal.

Table 7. Dual and Quad Mode BNC Connectors and Signals

Dual Mode				Quad Mode	
BNC #	Signal	BNC #	Signal	BNC #	Signal
1-2	1	17-18	9	1-4	1
3-4	2	19-20	10	5-8	2
5-6	3	21-22	11	9-12	3
7-8	4	23-24	12	13-16	4
9-10	5	25-26	13	17-20	5
11-12	6	27-28	14	21-24	6
13-14	7	29-30	15	25-28	7
15-16	8	31-32	16	29-32	8

Button Settings Using the Configuration screen, you can click on the name fields to assign custom Source and Destination names to the inputs and outputs of the router.

For any button, click outside the naming field to access the Button Settings panel.

The Settings selection allows you to pick a color from the settings panel to color code the control panel button backgrounds. The selected color is set for both the static state color and the High Tally (rollover/active) state.

Figure 33. Button Settings/Color Panel



Lock If you want to lock any of the Destinations from Source changes, click on the Lock/Unlock box for the desired Destination.

NOTE: *This lock is a universal lock for all KUMO devices controlling the selected Destination. It is tallied throughout the network and can be released from other KUMO control devices on the network.*

Hide You can also hide selected Destinations from display on the local Home control panel by activating the Show/Hide box.

Network Setup

The Network screen provides access to standard TCP-IP setup fields and allows you to click on the System Name field to change it. The MAC address is a fixed machine address composed of manufacturer identification and product serial numbers.

Click the Update Network Settings button to enter your settings.

Figure 34. KUMO Network Setup Screen

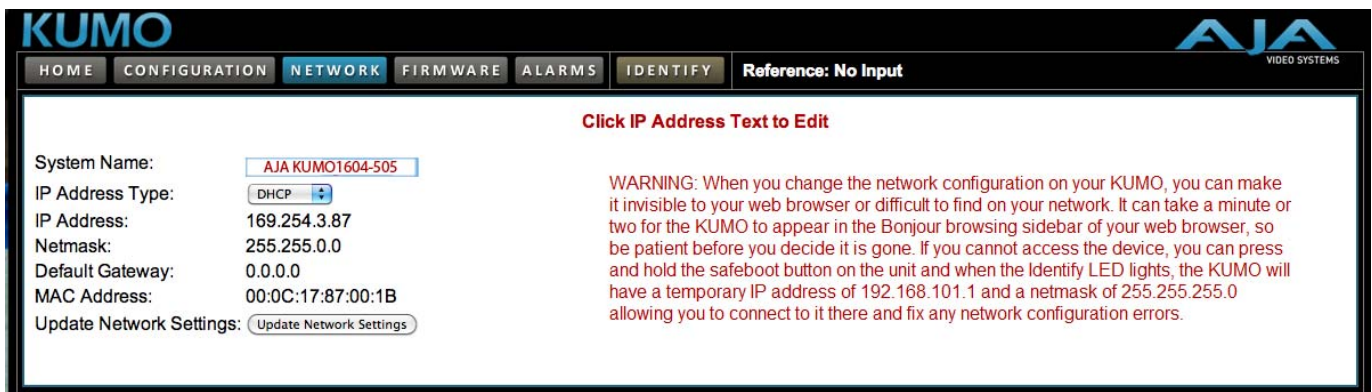

Firmware Updating

AJA is constantly upgrading its product software so it is a good idea to check the AJA website often for updates and to assure optimum system performance. Go to the AJA KUMO Update page by clicking the link at the bottom of the Firmware screen. Or, enter this URL in your web browser:

<http://www.aja.com/en/products/kumo/#support>

Current firmware version number is reported here under the pull-down menu.

Figure 35. KUMO Web Interface, Firmware Upload Screen

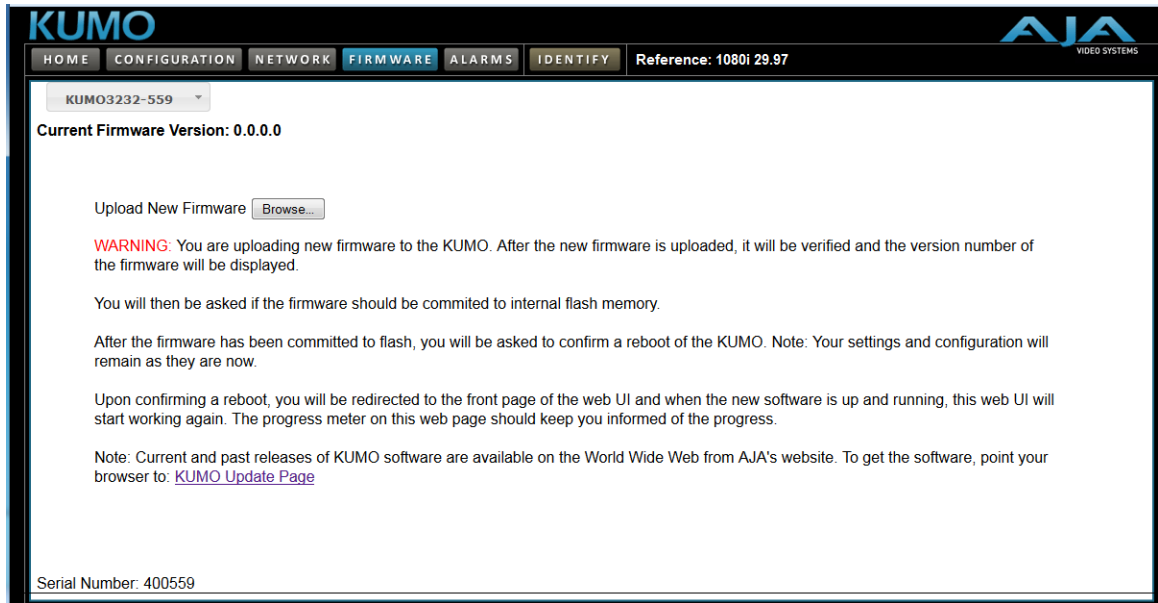

Unpack the Software Download the latest version of KUMO firmware and use the Firmware screen to upload it to your KUMO router. KUMO software update files are "ZIP" files, which you can open with a number of standard and third party uncompressor applications. The software image that you'll install on KUMO is a file with a name similar to:

- kumo_ver_1.1.1.**-1270485530.bin

NOTE: Depending on your PC or Mac operating system settings, the ".bin" extension may not be visible to you in a file directory.

Uploading and Installing Firmware to KUMO Uploading and installing the software update only requires a PC or Mac that can "see" the KUMO via its browser. Follow this procedure to install the software:

1. Point your browser at the downloaded KUMO upgrade file on your computer by clicking on the "Browse" button on the Firmware screen.

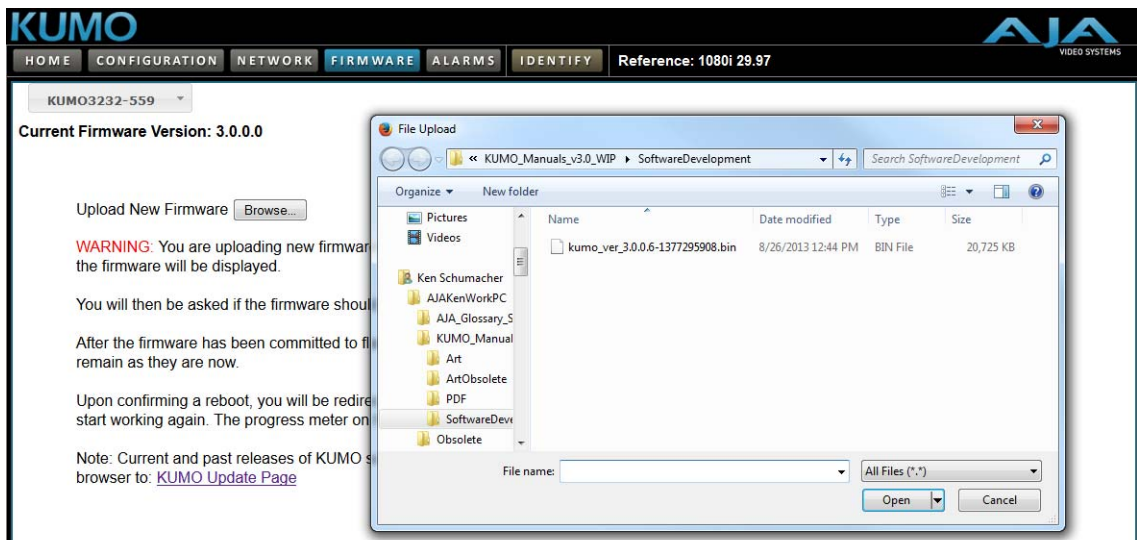

- When you have selected a valid KUMO image file, click **Open** and then **OK** the upload in the web browser. The file you select will upload to the KUMO and be tested for validity. Incomplete, corrupted, or non-KUMO software files are rejected.

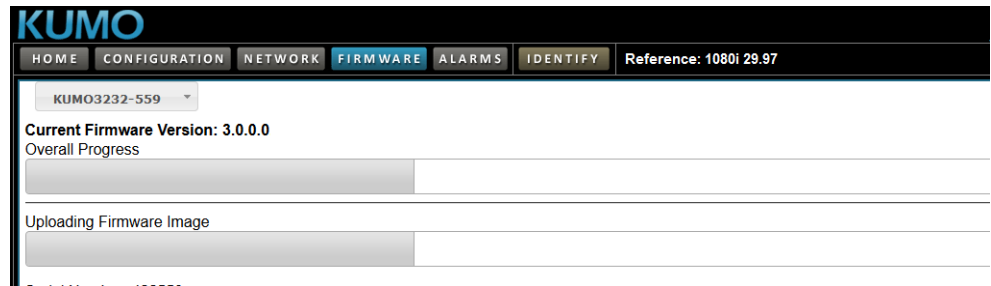

- When the upload completes you will be asked if you want to commit the firmware to flash.

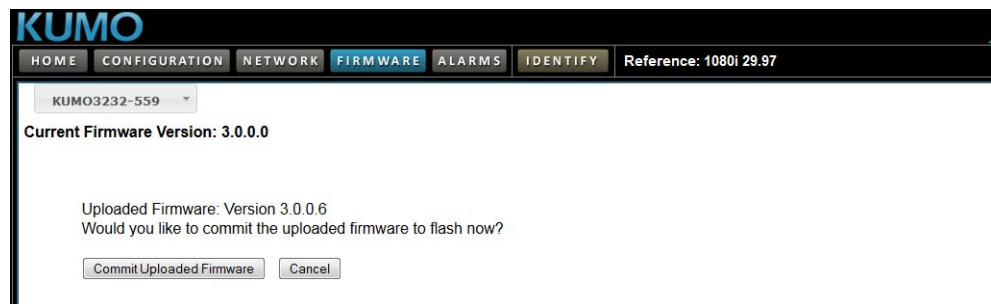

- Click **Commit Uploaded Firmware**. The firmware will be loaded to flash. Wait for this to complete.

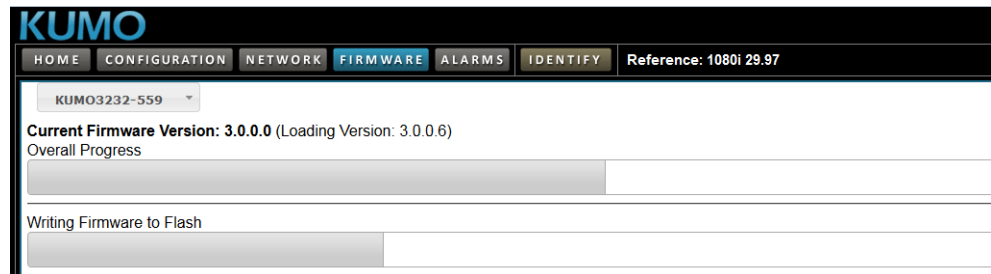

- When done, click the Restart button to reset your KUMO and refresh the web browser and KUMO UI.



Once these steps are complete, the KUMO will be running the software you just uploaded until the next time you upgrade it. The configuration of the KUMO prior to the upgrade is preserved.

Verify the new software is running by bringing up the KUMO web page again. Check the Firmware page for the current version number. The restart and refresh cycle may take a couple minutes. If for some rare reason it didn't update, you can then run through the update steps again.

NOTE: *On some browsers, the Retry page may appear even though the software upgrade was successful. If this occurs, before clicking on retry, refresh the web page and check the version number. If the new version number appears at the top of the page, the software upgrade was successful. If the old version appears, click Retry.*

If there is a power outage or glitch during the software download, the KUMO will boot the older software version and the upgrade process can then be re-started by the user. This happens because the KUMO has been designed with a safety feature where an internal "safe" copy of the previous software is retained in the event the updating process fails.

Safeboot Reset

If your KUMO software becomes corrupted to the point of freezing the device, you can always reset to the initial factory-installed safeboot firmware image by following these steps:

1. Power down the KUMO
2. Press and hold the reset button by inserting a paper clip or other device in the reset slot on the back of KUMO
3. Apply power to the router and after a moment release the reset.

NOTE: *A Safeboot Reset is also available for the KUMO CP, see "Shift/Reset Buttons" on page 45.*

Figure 36. KUMO Rear Panel and Reset Slot



KUMO Alarms

Kumo reports alarms on the router front panel by lighting an Alarm LED and in the web browser UI by illuminating the border of the Alarms tab (see below). Alarms include:

- Power Supply – displays error condition if a redundant power supply is off-line
- Reference – displays error condition if no valid video reference signal is found
- Over Temperature – displays error if KUMO exceeds normal operating temperature

Figure 37. KUMO Web Interface, Alarms Screen

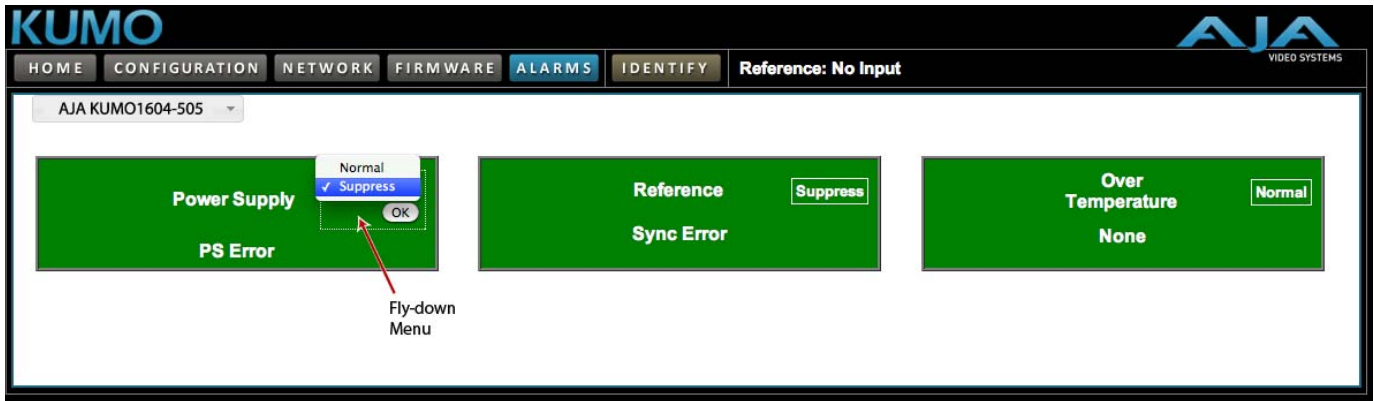

If you do not want any of the above conditions to report an error, right-click (Control/Opt-click) to access the fly-down menu shown above. Select Suppress to deactivate the specific alarm.

Locating a Specific KUMO

Click on the Identify button to flash the Identify LEDs on the front and back panels of the KUMO router enabling quick physical location of the router in a populated rack of equipment. Click again to turn it off

Figure 38. Identify LEDs.



Chapter 4: KUMO Remote Control Panel



The KUMO CP Control Panel is a destination-oriented panel allowing selection of up to 32 sources and destinations on each of up to four KUMO routers. The control panel will connect to a single KUMO router automatically without computer/browser interface. For connection to up to four routers at a time, use the KUMO browser interface to assign the router select buttons to any four KUMO routers on your network.

Figure 39. Direct Connect KUMO Control



Figure 40. Networked KUMO Control

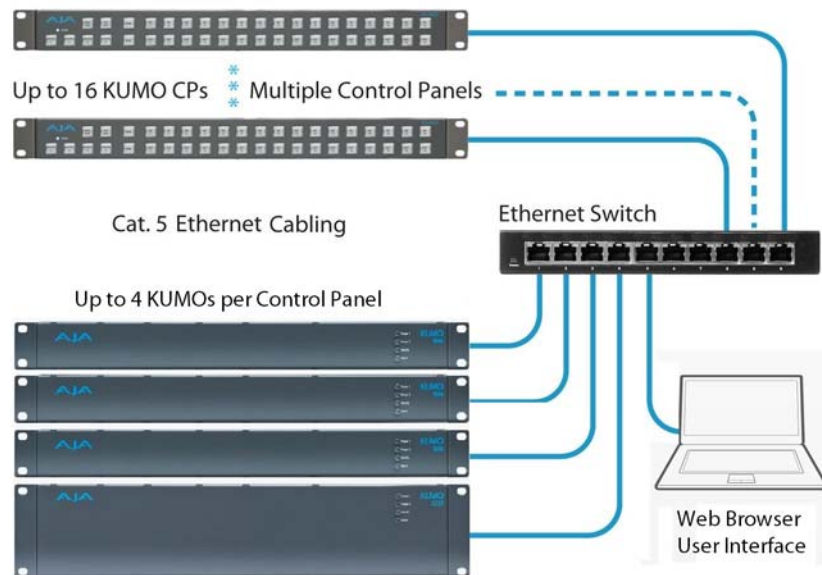

In this multi-router network configuration with Ethernet connection between control panels and routers, the Router Delegation Buttons (shown below) are assigned to up to four active routers using the control panel web interface (for details, see ["Home Page" on page 45](#)).

Connectors and Indicator

KUMO CP provides inputs for two power supplies—one included, redundant supply optional. An RJ-45 connector provides 10/100/1000 Ethernet connection to the internal Linux OS/web server.

Figure 41. KUMO CP Connectors and Indicator



Button Key Caps Each control panel button has a removable lens cap that allows you to customize Source and Destination names. AJA has provided a template for printing custom lens chips (we suggest using 29 lb. vellum) for button designations. The template is available on your software CD and at:

http://www.aja.com/support/kumo/lens_chip.zip

Panel Function Buttons

Each KUMO Control Panel provides:

- Panel Lock – prevents Source or Destination changes from this panel.
- Destination Lock – prevents any Source change for a Destination.
- Router Delegation Buttons – (RTR 1–RTR 4) enable immediate control of the KUMO assigned to the button.

Figure 42. KUMO CP Function Buttons



Panel Lock When you press the Panel Lock button, it lights red and all panel functions for this panel are disabled. All other KUMO devices on the network will function normally.

Destination Lock Press the Destination (Dest) Lock button to prevent any changes to the KUMO destination you are currently controlling (Dest button high tallied). The lock can be removed from any other KUMO CP or browser interface on the network.

The DEST and DEST LOCK buttons turn red on all panels that are assigned to the KUMO you are controlling. You can select other destinations and apply the Dest Lock function to each. All locks will tally red. To remove the lock, select the destination and press Dest Lock again.

NOTE: Locked destinations are reported on the KUMO router's browser Home page with a lock icon.

Figure 43. KUMO Router Home Page Destination Buttons



Router Delegation Buttons (RTR 1 - 4)

Use the Router delegate buttons to connect to the specific router to be controlled.

If you are using the KUMO web browser interface, you can assign the delegate buttons to any of up to four routers in your system. To assign router/control panel delegation, you will access the Home page for your KUMO CP.

Shift/Reset Buttons

The SHIFT SRC and SHIFT DEST buttons serve multiple functions. They allow you to select shifted sources and destinations (17–32), and they also perform the same reset functions as the reset slot. Resets should be done only by qualified network personnel:

- **Shift:** Hold down SHIFT SRC and press a source button to select a shifted source, or hold down SHIFT DEST and press a destination button to select a shifted destination. When a shift button is not held down, pressing a source or destination button selects the unshifted source or destination (1–16).
- **IP Reset:** Hold both buttons down for five seconds to perform an IP address reset to the temporary default IP address (see [“KUMO Temporary Static IP Address” on page 16](#)).
- **Reset to Factory Default Firmware:** Hold both buttons down at power up to perform a Safeboot Reset to the Factory Default firmware image.

Control Panel Browser Interface

The KUMO CP browser interface provides the same Navigation Bar tabs as the router. This section discusses those functions unique to the control panel interface. The Navigation Bar includes:

- Home – assign router elect buttons to KUMO routers
- Configuration – adjust the control panel display intensity and, if necessary, Reset the panel to its original “Auto Configure” state or to original factory settings
- Network and Firmware tabs – same as KUMO router network settings, see [“Network Setup” on page 38](#) and [“Firmware Updating” on page 38](#).
- Alarms – Power Supply and Over Temperature, refer to [“KUMO Alarms” on page 41](#).
- Identify button – to identify the physical location of a particular control panel.

Home Page

Use the Home page to assign a router to each of the panel select buttons. Each button has a pull-down menu that lists the active networked KUMOs for assignment and provides an Unassign and Refresh function.

Figure 44. KUMO CP Browser Interface Home Page

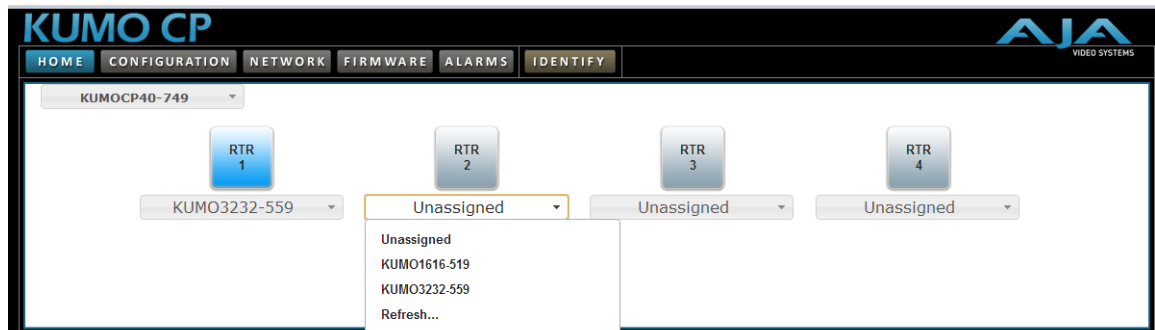

The assigned router name appears below each button. You can change the selected (currently-controlled) router on the panel by clicking the a button on the Home page. The panel's router select button will tally appropriately.

Configuration Page Using the Configuration page, you can:

- Adjust the Display Intensity slider – select one of four button illumination levels.
- Reset “Auto Configure” – resets the Auto Configure function to automatically set up one control panel to one router. This function re-boots the panel to trigger the configuration. Upon reboot, if any other router is found on the network, it will not pair to the panel.
- Reset to Factory Defaults – resets all user settings to factory defaults.

Figure 45. KUMO CP Browser Configuration Page



Network Page The Network screen provides access to standard TCP-IP setup fields and allows you to click on the System Name field to change it. The MAC address is a fixed machine address composed of manufacturer identification and product serial numbers.

Click the Update Network Settings button to enter your settings.

Figure 46. KUMO CP Network Setup Screen

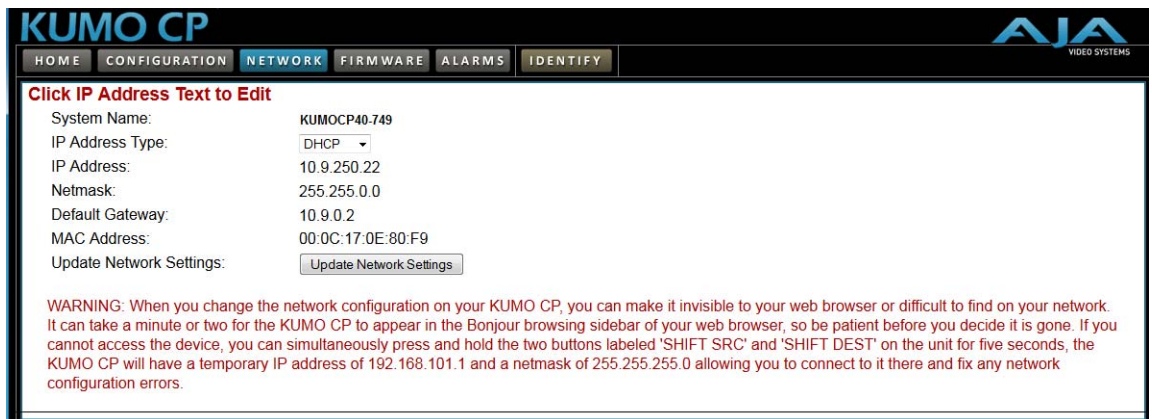

Identify Button Click on the Identify button to find the physical location of currently controlled panel. KUMO CP Identify Button



The web browser button will alternate between blue and gray background color in Identify mode. On the connected control panel, the Source and Destination button rows will flash alternately. Also, the Identify LED on the back of the panel will flash. Click a second time to resume normal operation.

Appendix A: Specifications

KUMO SDI Router Specifications

Formats	3.0 Gbps, 1.5 Gbps, 270 Mbps, DVB-ASI, Auto Select
Video Inputs/Outputs Standards	SDI (SMPTE 259/292/296 and 424) BNC
Video Output Reclocker	SMPTE 259/292/424 compliant, automatic rate selection
Cable Equalization (BNC inputs, 1694 coax)	270 Mb – 400 meters 1.5 Gb – 200 meters 3 Gb – 140 meters
Input/Output Return Loss (BNC)	>15dB to 270Mb, > 10db 1.5Gb to 3Gb
Reference Input	<ul style="list-style-type: none">• Analog input, passive looping BNCs• Format: NTSC, PAL, Tri-level sync
Control	<ul style="list-style-type: none">• 10/100/1000 Ethernet, RJ-45, internal Linux OS/web server• RS-422 Serial DB9 female
Environment	<ul style="list-style-type: none">• Operating Temperature: 0 to 40 Degrees C• Relative Humidity: 0 to 90%, non-condensing
Power	<ul style="list-style-type: none">• 100-240 VAC 50/60Hz, 9-17 VDC, +12 VDC nominal• Optional redundant power supply (p/n KUMO-PWR-R0) <p>KUMO 1604 – 7.5 Watts, 0.8A at 12VDC KUMO 1616 – 20 Watts, 1.8A at 12VDC KUMO 3232 – 26.4 Watts, 2.2A at 12VDC</p>
Size	Depth – 1 RU 1.5" (38.1 mm); 2 RU 1.543" (39.2 mm) Height – 1 RU 1.72" (43.7 mm); 2 RU 3.47" (88.14 mm) Width – 1 RU and 2 RU 19" (483 mm)
Weight	KUMO 1604 – 1.2 lb. (.55 kg) KUMO 1616 – 1.4 lb. (.64 kg) KUMO 3232 – 4.58 lbs. (2.1 kg)
SDI Signal Switch Note	KUMO routers switch SDI signals in a manner compliant with SMPTE RP168-2009. Because KUMO routers (or any similar router) switch the SDI stream without de-serializing, the switch point can cause a temporary anomaly in the SDI stream. This can cause downstream equipment, depending on the characteristics of the SDI receiver(s), to react to the switch (for example, a monitor "glitch or roll"). It is also possible that switching anomalies can appear on just one or more outputs in the same group in the Dual and Quad modes. This effect occurs regardless of the relative timing of the SDI signals being switched, or any reference input connected to the router.

KUMO CP Specifications

Control	• 10/100/1000 Ethernet, RJ-45, internal Linux OS/web server
Environment	• Operating Temperature 0 to 40 Degrees C • Relative Humidity: 0 to 90%, non-condensing
Power	100-240 VAC 50/60Hz, 9-17 VDC, 12 VDC nominal, optional redundant power supply KUMO CP – 4 Watts, 0.4A at 12VDC
KUMO CP Size	Depth – 1.07" (27.3 mm) Height – 1.72" (43.7 mm) Width – 19" (483 mm)
KUMO CP Weight	1.2 lb. (.55 kg)

GVG Native Protocol Support

Introduced with v2.0 firmware, KUMO provides basic support for the GVG Native Protocol, aka Series 7000 Native Protocol. GVG Native Protocol, using:

- 1 serial connection via RS-422 with a 9-pin connector
- TCP/Ethernet for up to 10 connections

For for information, refer to Grass Valley documentation at:

http://www.grassvalley.jp/pdf/RoutingProductsProtocolManual_2.pdf

NP Commands Supported: **Background:**

- BK, I; Connect, heartbeat
- BK, N; Gets system name
- BK, T; Gets Software Title
- BK, t; Gets Protocol Software
- BK, R; Gets software Version
- BK, d; Gets device name.

Queries:

- QN, S; Gets all srcs by name
- QN, IS; Gets All srcs, name & index
- QN, D; Gets All dests, names
- QN, ID; Gets All dests, name & indx
- QN, L; Gets levels (hard coded as "Kumo_Lev0")
- QD, {destname}; Gets: protect {On/Off}, chop{=OFF}, {sourceName}, level{= lev0}
- Qd, {destname}; Gets: protect {On/Off}, chop{=OFF}, {sourceName}, level{= lev0}

Control:

- TD,{destname,srcname};Takes by name
- TI,{destIdx,srcIdx}; Takes by index
- PR,{destname, levelmask} Sets lock for given dest.
- UP,{destname, levelmask} Unsets lock for given dest.

RS-422 Control Specifications

- Baud Rate: 38400
- Parity: None
- Stop Bit: 1
- Data Bits: 8

Serial Port: RS-422 (slave pinout), 9-pin (available beginning with version 2.0 firmware)—Connector pinout is as follows:

1. GND
 2. TX-
 3. RX+
 4. GND
 5. No Connection
 6. GND
 7. TX+
 8. RX-
 9. GND
- Shell. GND

Ethernet Control Specifications

Ethernet Control Port: TCP/IP Port 12345

Appendix B: Safety & Compliance

Federal Communications Commission (FCC) Compliance Notices

Class A Interference Statement

This equipment has been tested and found to comply with the limits for a Class A digital device, pursuant to Part 15, Subpart B of the FCC Rules. These limits are designed to provide reasonable protection against harmful interference in a commercial installation. This equipment generates, uses, and can radiate radio frequency energy and, if not installed and used in accordance with the instructions, may cause harmful interference to radio communications. However, there is no guarantee that interference will not occur in a particular installation. Operation of this equipment in a residential area is likely to cause harmful interference in which case the user will be required to correct the interference at his own expense. If this equipment does cause harmful interference to radio or television reception, which can be determined by turning the equipment off and on, the user is encouraged to try to correct the interference by one or more of the following measures:

- Reorient or relocate the receiving antenna.
- Increase the separation between the equipment and receiver.
- Connect the equipment into an outlet on a circuit different from that to which the receiver is connected.
- Consult the dealer or an experienced radio/TV technician for help.

FCC Caution

This device complies with Part 15 of the FCC Rules. Operation is subject to the following two conditions: (1) This device may not cause harmful interference, and (2) this device must accept any interference received, including interference that may cause undesired operation.

Canadian ICES Statement

Canadian Department of Communications Radio Interference Regulations

This digital apparatus does not exceed the Class A limits for radio-noise emissions from a digital apparatus as set out in the Radio Interference Regulations of the Canadian Department of Communications. This Class A digital apparatus complies with Canadian ICES-003.

Règlement sur le brouillage radioélectrique du ministère des Communications

Cet appareil numérique respecte les limites de bruits radioélectriques visant les appareils numériques de classe A prescrites dans le Règlement sur le brouillage radioélectrique du ministère des Communications du Canada. Cet appareil numérique de la Classe A est conforme à la norme NMB-003 du Canada.

European Union and European Free Trade Association (EFTA) Regulatory Compliance

This equipment may be operated in the countries that comprise the member countries of the European Union and the European Free Trade Association. These countries, listed in the following paragraph, are referred to as The European Community throughout this document:

AUSTRIA, BELGIUM, BULGARIA, CYPRUS, CZECH REPUBLIC, DENMARK, ESTONIA, FINLAND, FRANCE, GERMANY, GREECE, HUNGARY, IRELAND, ITALY, LATVIA, LITHUANIA, LUXEMBOURG, MALTA, NETHERLANDS, POLAND, PORTUGAL, ROMANIA, SLOVAKIA, SLOVENIA, SPAIN, SWEDEN, UNITED KINGDOM, ICELAND, LICHTENSTEIN, NORWAY, SWITZERLAND

Declaration of Conformity

Marking by this symbol indicates compliance with the Essential Requirements of the EMC Directive of the European Union 2004/108/EC.



This equipment meets the following conformance standards:

Safety: CB- IEC 60065:2001 + A1:2005

NRTL - UL 60065:2003 R11.06, CSA C22.2 NO. 60065:2003 + A1:06

GS - EN 60065:2002 + A1

Additional licenses issued for specific countries available on request.

Emissions: EN 55103-1: 1996

EN61000-3-2:2006, EN61000-3-3:1995 +A1:2001 +A2:2005

Immunity: EN 55103-2: 1996

EN61000-4-2:1995 + A1:1999 + A2:2001, EN61000-4-3:2006, EN61000-4-4:2004,

EN 61000-4-5: 2005, EN 61000-4-6:2007, EN61000-4-11:2004

The product is also licensed for additional country specific standards as required for the International Marketplace.



Caution!

This is a Class A product. In a domestic environment, this product may cause radio interference, in which case, the user may be required to take appropriate measures.

Achtung! Dieses ist ein Gerät der Funkstörgrenzwertklasse A. In Wohnbereichen können bei Betrieb dieses Gerätes Rundfunkstörungen auftreten, in welchen Fällen der Benutzer für entsprechende Gegenmaßnahmen verantwortlich ist.

Attention! Ceci est un produit de Classe A. Dans un environnement domestique, ce produit risque de créer des interférences radioélectriques, il appartiendra alors à l'utilisateur de prendre les mesures spécifiques appropriées.

Korea KCC Compliance Statement

A급 기기 (업무용 방송통신기자재)	이 기기는 업무용(A급) 전자파적합기기로서 판매자 또는 사용자는 이 점을 주의하시기 바라며, 가정외의 지역에서 사용하는 것을 목적으로 합니다.
Class A (Broadcasting Communication Equipment for Office Use)	As an electromagnetic wave equipment for office use (Class A), this equipment is intended to use in other than home area. Sellers or users need to take note of this.

Taiwan Compliance Statement

警告使用者：
這是甲類的資訊產品，在居住的環境中使用時，可能會造成射頻干擾，在這種情況下，使用者會被要求採取某些適當的對策。

This is a Class A product based on the standard of the Bureau of Standards, Metrology and Inspection (BSMI) CNS 13438, Class A.

Japanese Compliance Statement

1. Class A ITE

この装置は、クラスA 情報技術装置です。この装置を家庭環境で使用すると電波妨害を引き起こすことがあります。この場合には使用者が適切な対策を講ずるよう要求されることがあります。VCCI-A

This is a Class A product based on the standard of the VCCI Council (VCCI V-3/2008.04). If this equipment is used in a domestic environment, radio interference may occur, in which case, the user may be required to take corrective actions.

Translated Warning and Caution Messages

The following caution statements, warning conventions, and warning messages apply to this product and manual.



Warning Symbol



Caution Symbol

Before Operating Please Read These Instructions

**Warning!**

Read and follow all warning notices and instructions marked on the product or included in the documentation.

Avertissement ! Lisez et conformez-vous à tous les avis et instructions d'avertissement indiqués sur le produit ou dans la documentation.

Warnung! Lesen und befolgen Sie die Warnhinweise und Anweisungen, die auf dem Produkt angebracht oder in der Dokumentation enthalten sind.

¡Advertencia! Lea y siga todas las instrucciones y advertencias marcadas en el producto o incluidas en la documentación.

Aviso! Leia e siga todos os avisos e instruções assinalados no produto ou incluídos na documentação.

Avviso! Leggere e seguire tutti gli avvisi e le istruzioni presenti sul prodotto o inclusi nella documentazione.

**Warning!**

Do not use this device near water and clean only with a dry cloth.

Avertissement! N'utilisez pas cet appareil près de l'eau et nettoyez-le seulement avec un tissu sec..

Warnung! Das Gerät nicht in der Nähe von Wasser verwenden und nur mit einem trockenen Tuch säubern.

¡Advertencia! No utilice este dispositivo cerca del agua y límpielo solamente con un paño seco.

Aviso! Não utilize este dispositivo perto da água e limpe-o somente com um pano seco.

Avviso! Non utilizzare questo dispositivo vicino all'acqua e pulirlo soltanto con un panno asciutto.

**Warning!**

Do not block any ventilation openings. Install in accordance with the manufacturer's instructions.

Avertissement ! Ne bloquez aucune ouverture de ventilation. Suivez les instructions du fabricant lors de l'installation.

Warnung! Die Lüftungsöffnungen dürfen nicht blockiert werden. Nur gemäß den Anweisungen des Herstellers installieren.

¡Advertencia! No bloquee ninguna de las aberturas de la ventilación. Instale de acuerdo con las instrucciones del fabricante.

Aviso! Não obstrua nenhuma das aberturas de ventilação. Instale de acordo com as instruções do fabricante.

Avviso! Non ostruire le aperture di ventilazione. Installare in conformità con le istruzioni del fornitore.

**Warning!**

Do not install near any heat sources such as radiators, heat registers, stoves, or other apparatus (including amplifiers) that produce heat.

Avertissement ! N'installez pas l'appareil près d'une source de chaleur telle que des radiateurs, des bouches d'air de chauffage, des fourneaux ou d'autres appareils (amplificateurs compris) qui produisent de la chaleur.

Warnung! Nicht in der Nähe von Wärmequellen wie Heizkörpern, Heizregistern, Öfen oder anderen Wärme erzeugenden Geräten (einschließlich Verstärkern) aufstellen.

¡Advertencia! No instale cerca de fuentes de calor tales como radiadores, registros de calor, estufas u otros aparatos (incluidos amplificadores) que generan calor.

Aviso! Não instale perto de nenhuma fonte de calor tal como radiadores, saídas de calor, fogões ou outros aparelhos (incluindo amplificadores) que produzam calor.

Avviso! Non installare vicino a fonti di calore come termosifoni, diffusori di aria calda, stufe o altri apparecchi (amplificatori compresi) che emettono calore.

**Warning!**

Do not defeat the safety purpose of the polarized or grounding-type plug. A polarized plug has two blades with one wider than the other. A grounding type plug has two blades and a third grounding prong. The wide blade or the third prong are provided for your safety. If the provided plug does not fit into your outlet, consult an electrician for replacement of the obsolete outlet.

Avertissement! La sécurité de la prise polarisée ou de la prise de type mise à la terre ne doit en aucun cas être empêchée de fonctionner. Une prise polarisée a deux broches, l'une étant plus large que l'autre. Une prise de type mise à la terre a deux broches et une troisième broche pour la mise à la terre. La broche large ou la troisième broche sont fournies pour votre sécurité. Si la prise fournie ne s'insère pas dans votre prise femelle, consultez un électricien pour le remplacement de la prise femelle obsolète.

Warnung! Der Sicherheitszweck des gepolten bzw. Schukosteckers ist zu berücksichtigen. Ein gepolter Stecker verfügt über zwei Pole, von denen einer breiter als der andere ist. Ein Schukostecker verfügt neben den zwei Polen noch über einen dritten Pol zur Erdung. Der breite Pol bzw. der Erdungspol dienen der Sicherheit. Wenn der zur Verfügung gestellte Stecker nicht in Ihren Anschluss passt, konsultieren Sie einen Elektriker, um den veralteten Anschluss zu ersetzen.

¡Advertencia! No eche por tierra la finalidad del tipo de enchufe polarizado con conexión a tierra. Un enchufe polarizado tiene dos espigas, una más ancha que la otra. Un enchufe con conexión a tierra tiene dos espigas iguales y una tercera espiga que sirve para la conexión a tierra. La espiga ancha, o la tercera espiga, sirven para su seguridad. Si el enchufe suministrado no encaja en el tomacorriente, consulte con un electricista para reemplazar el tomacorriente obsoleto.

Aviso! Não anule a finalidade da segurança da ficha polarizada ou do tipo ligação terra. Uma ficha polarizada tem duas lâminas sendo uma mais larga do que a outra. Uma ficha do tipo de ligação à terra tem duas lâminas e um terceiro terminal de ligação à terra. A lâmina larga ou o terceiro terminal são fornecidos para sua segurança. Se a ficha fornecida não couber na sua tomada, consulte um electricista para a substituição da tomada obsoleta.

Avviso! Non compromettere la sicurezza della spina polarizzata o con messa a terra. Una spina polarizzata ha due spinotti, di cui uno più largo. Una spina con messa a terra ha due spinotti e un terzo polo per la messa a terra. Lo spinotto largo o il terzo polo sono forniti per motivi di sicurezza. Se la spina fornita non si inserisce nella presa di corrente, contattare un elettricista per la sostituzione della presa obsoleta.

**Warning!**

Since the Mains plug is used as the disconnection for the device, it must remain readily accessible and operable.

Avertissement! Puisque la prise principale est utilisée pour débrancher l'appareil, elle doit rester aisément accessible et fonctionnelle.

Warnung! Da der Netzstecker als Trennvorrichtung dient, muss er stets zugänglich und funktionsfähig sein.

¡Advertencia! Puesto que el enchufe de la red eléctrica se utiliza como dispositivo de desconexión, debe seguir siendo fácilmente accesible y operable.

Aviso! Dado que a ficha principal é utilizada como a desconexão para o dispositivo, esta deve manter-se prontamente acessível e funcional.

Avviso! Poiché il cavo di alimentazione viene usato come dispositivo di sconnessione, deve rimanere prontamente accessibile e operabile.

**Warning!**

Protect the power cord from being walked on or pinched particularly at plugs, convenience receptacles, and the point where they exit from the device.

Avertissement! Protégez le cordon d'alimentation pour que l'on ne marche pas dessus ou qu'on le pince, en particulier au niveau des prises mâles, des réceptacles de convenance, et à l'endroit où il sort de l'appareil.

Warnung! Vermeiden Sie, dass auf das Netzkabel getreten oder das Kabel geknickt wird, insbesondere an den Steckern, den Steckdosen und am Kabelausgang am Gerät.

¡Advertencia! Proteja el cable de energía para que no se le pise ni apriete, en especial cerca del enchufe, los receptáculos de conveniencia y el punto del que salen del equipo.

Aviso! Proteja o cabo de alimentação de ser pisado ou de ser comprimido particularmente nas fichas, em tomadas de parede de conveniência e no ponto de onde sai do dispositivo.

Avviso! Proteggere il cavo di alimentazione in modo che nessuno ci cammini sopra e che non venga schiacciato soprattutto in corrispondenza delle spine e del punto in cui esce dal dispositivo.

**Warning!**

Unplug this device during lightning storms or when unused for long periods of time.

Avertissement! Débranchez cet appareil pendant les orages avec éclairs ou s'il est inutilisé pendant de longues périodes.

Warnung! Das Gerät ist bei Gewitterstürmen oder wenn es über lange Zeiträume ungenutzt bleibt vom Netz zu trennen.

¡Advertencia! Desenchufe este dispositivo durante tormentas eléctricas o cuando no se lo utilice por largos periodos del tiempo.

Aviso! Desconecte este dispositivo da tomada durante trovoadas ou quando não é utilizado durante longos períodos de tempo.

Avviso! Utilizzare soltanto i collegamenti e gli accessori specificati e/o venduti dal produttore, quali il treppiedi e l'esoscheletro.

**Warning!**

Refer all servicing to qualified service personnel. Servicing is required when the device has been damaged in any way, such as power-supply cord or plug is damaged, liquid has been spilled or objects have fallen into the device, the device has been exposed to rain or moisture, does not operate normally, or has been dropped.

Avertissement ! Référez-vous au personnel de service qualifié pour tout entretien. L'entretien est exigé quand l'appareil a été endommagé de quelque manière que ce soit, par exemple lorsque le cordon d'alimentation ou la prise sont endommagés, que du liquide a été versé ou des objets sont tombés dans l'appareil, que l'appareil a été exposé à la pluie ou à l'humidité, ne fonctionne pas normalement ou est tombé.

Warnung! Das Gerät sollte nur von qualifizierten Fachkräften gewartet werden. Eine Wartung ist fällig, wenn das Gerät in irgendeiner Weise beschädigt wurde, wie bei beschädigtem Netzkabel oder Netzstecker, falls Flüssigkeiten oder Objekte in das Gerät gelangen, das Gerät Regen oder Feuchtigkeit ausgesetzt wurde, nicht ordnungsgemäß funktioniert oder fallen gelassen wurde.

¡Advertencia! Consulte al personal calificado por cuestiones de reparación. El servicio de reparación se requiere cuando el dispositivo ha recibido cualquier tipo de daño, por ejemplo cable o espigas dañadas, se ha derramado líquido o se han caído objetos dentro del dispositivo, el dispositivo ha sido expuesto a la lluvia o humedad, o no funciona de modo normal, o se ha caído.

Aviso! Remeta todos os serviços de manutenção para o pessoal de assistência qualificado. A prestação de serviços de manutenção é exigida quando o dispositivo foi danificado mediante qualquer forma, como um cabo de alimentação ou ficha que se encontra danificado/a, quando foi derramado líquido ou caíram objectos sobre o dispositivo, quando o dispositivo foi exposto à chuva ou à humidade, quando não funciona normalmente ou quando foi deixado cair.

Avviso! Fare riferimento al personale qualificato per tutti gli interventi di assistenza. L'assistenza è necessaria quando il dispositivo è stato danneggiato in qualche modo, ad esempio se il cavo di alimentazione o la spina sono danneggiati, è stato rovesciato del liquido è stato rovesciato o qualche oggetto è caduto nel dispositivo, il dispositivo è stato esposto a pioggia o umidità, non funziona correttamente o è caduto.

**Caution!**

This device is a Class A product. Operation of this equipment in a residential area is likely to cause harmful interference, in which case users will be required to take whatever measures may be necessary to correct the interference at their own expense.

Attention! Le périphérique est un produit de Classe A. Le fonctionnement de cet équipement dans une zone résidentielle risque de causer des interférences nuisibles, auquel cas l'utilisateur devra y remédier à ses propres frais.

Achtung! Dies ist ein Gerät der Klasse A. Bei Einsatz des Geräts in Wohngebieten kann es Störungen des Radio- und Fernsehempfangs verursachen. In diesem Fall muss der Benutzer alle notwendigen Maßnahmen ergreifen, die möglicherweise nötig sind, um die Störungen auf eigene Rechnung zu beheben.

¡Precaución! Este es un producto clase A. El uso de este equipo en áreas residenciales puede causar interferencias nocivas, en cuyo caso, se requerirá que los usuarios tomen cualquier medida necesaria para corregir la interferencia por cuenta propia.

Cuidado! Este dispositivo é um produto Classe A. Operar este equipamento em uma área residencial provavelmente causará interferência prejudicial; neste caso, espera-se que os usuários tomem as medidas necessárias para corrigir a interferência por sua própria conta.

Attenzione! Questo dispositivo è un prodotto di Classe A. Il funzionamento di questo apparecchio in aree residenziali potrebbe causare interferenze dannose, nel cui caso agli utenti verrà richiesto di adottare tutte le misure necessarie per porre rimedio alle interferenze a proprie spese.

**Caution!**

To meet safety regulations for leakage current when using redundant power supplies, connect the KUMO dual power supplies to separate branch circuits.

Attention! Pour satisfaire aux réglementations sur la sécurité concernant le courant de fuite pendant l'utilisation d'appareils fournisseurs d'alimentation redondants, branchez les deux appareils fournisseurs d'alimentation KUMO à des circuits de dérivation distincts.

Achtung! Um die Einhaltung aller Sicherheitsbestimmungen bzgl. Ableitstrom beim Einsatz von redundanten Netzteilen sicherzustellen, schließen Sie die zwei KUMO-Netzteile bitte an separate Abzweigungen an.

¡Precaución! Para cumplir con las regulaciones de seguridad con el propósito de evitar pérdidas de corriente cuando se utiliza fuentes de alimentación múltiples, conecte las fuentes de alimentación dual KUMO a circuitos independientes.

Atenção! Para atender às regulamentações de segurança relativas à corrente de fuga ao usar fontes de alimentação redundantes, conecte as fontes de alimentação duplas KUMO para separar os circuitos derivados.

Attenzione! Per soddisfare i requisiti di sicurezza per la corrente di dispersione usando alimentatori ridondanti, collegare i doppi alimentatori KUMO per separare i circuiti derivati.

**Caution!**

KUMO is designed to take advantage of its chassis to aid in cooling. It is common and expected for the densely populated 1616 chassis to have a warm front panel in normal, active operating conditions.

Attention! KUMO est conçu pour tirer parti de son châssis pour le refroidissement. Il est normal et attendu que le panneau frontal du très compact châssis 1616 demeure chaud dans des conditions normales de fonctionnement .

Achtung! Das Design von KUMO nutzt das Gehäuse zur Kühlung. Es ist normal und entspricht den Erwartungen, dass die Vorderseite des dicht bestückten 1616-Gehäuses bei normalen, aktiven Betriebsbedingungen warm ist.

¡Precaución! KUMO está diseñado para aprovechar el chasis para asistir en el proceso de enfriamiento. Es común y está previsto que el chasis 1616 densamente surtido de componentes tenga el panel frontal caliente en condiciones normales y activas de funcionamiento.

Atenção! O KUMO foi projetado para aproveitar seu chassi para auxiliar no resfriamento. É normal e esperado que o chassi 1616 densamente preenchido apresente um painel frontal aquecido em condições de operação normais e ativas.

Attenzione! KUMO sfrutta lo chassis per migliorare il raffreddamento. È normale per lo chassis 1616, data la concentrazione di cavi, che il pannello anteriore si riscaldi durante la normale attività.

**Warning!**

Do not open the chassis. There are no user-serviceable parts inside. Opening the chassis will void the warranty unless performed by an AJA service center or licensed facility.

Avertissement! Ne pas ouvrir le châssis. Aucun élément à l'intérieur du châssis ne peut être réparé par l'utilisateur. La garantie sera annulée si le châssis est ouvert par toute autre personne qu'un technicien d'un centre de service ou d'un établissement agréé AJA.

Warnung! Öffnen Sie das Gehäuse nicht. Keine der Geräteteile können vom Benutzer gewartet werden. Durch das Öffnen des Gehäuses wird die Garantie hinfällig, es sei denn, solche Wartungsarbeiten werden in einem AJA-Service-Center oder einem lizenzierten Betrieb vorgenommen.

¡Advertencia! No abra el chasis. El interior no contiene piezas reparables por el usuario. El abrir el chasis anulará la garantía a menos que se lo haga en un centro de servicio AJA o en un local autorizado.

Advertência! Não abra o chassi. Não há internamente nenhuma peça que permita manutenção pelo usuário. Abrir o chassi anula a garantia, a menos que a abertura seja realizada por uma central de serviços da AJA ou por um local autorizado.

Avvertenza! Non aprire lo chassis. All'interno non ci sono parti riparabili dall'utente. L'apertura dello chassis invaliderà la garanzia se non viene effettuata da un centro ufficiale o autorizzato AJA.

**Warning!**

Disconnect the external AC power supply line cord(s) from the mains power before moving the unit.

Avertissement! Retirez le ou les cordons d'alimentation en CA de la source d'alimentation principale lorsque vous déplacez l'appareil.

Warnung! Trennen Sie die Wechselstrom-Versorgungskabel vom Netzstrom, bevor Sie das Gerät verschieben.

¡Advertencia! Cuando mueva la unidad desenchufe de la red eléctrica el/los cable(s) de la fuente de alimentación CA tipo brick.

Advertência! Remova os cabos CA de alimentação brick da rede elétrica ao mover a unidade.

Avvertenza! Scollegare il cavo dell'alimentatore quando si sposta l'unità.

**Caution!**

When attaching KUMO to a standard Static IP LAN, you must configure KUMO components with a new, unique IP address. You should first talk to your network administrator and find out how it should be connected (TCP/IP Static IP or DHCP). Your IT department will be able to supply the information you need to install KUMO on a LAN. Methods for assigning Static IP addressing are discussed in the KUMO Installation and Operation manual.

Attention! Lorsque vous branchez l'appareil KUMO à un réseau LAN IP fixe standard, vous devez configurer les composants KUMO avec une nouvelle adresse IP qui soit unique. Vous devez d'abord consulter votre administrateur réseau pour savoir comment connecter l'appareil (TCP/IP, IP fixe ou DHCP). Votre service informatique pourra vous fournir les informations nécessaires pour installer KUMO sur un réseau LAN. Les méthodes d'attribution des adresses IP fixes sont traitées dans le manuel d'installation et de fonctionnement de KUMO.

Achtung! Beim Anschließen von KUMO an ein standardmäßiges statisches IP-LAN müssen Sie die KUMO-Komponenten mit einer neuen, einzigartigen IP-Adresse konfigurieren. Fragen Sie bei Ihrem Netzwerkadministrator nach, wie der Anschluss erfolgen soll (TCP/IP statische IP oder DHCP). Ihre IT-Abteilung kann Ihnen zudem alle nötigen Informationen liefern, die Sie zur Installation von KUMO auf einem LAN benötigen. Die Methoden zur Zuweisung von statischen IP-Adressen werden im KUMO Installations- und Benutzerhandbuch besprochen.

¡Precaución! Cuando conecte KUMO a una LAN de IP estática estándar, deberá configurar los componentes KUMO con una dirección de IP nueva y única. Primero deberá contactarse con su administrador de red y averiguar el método de conexión (IP estática TCP/IP o DHCP). Su departamento de TI podrá suministrarle la información que necesita para instalar KUMO en una LAN. Los métodos para asignar direcciones IP estáticas se presentan en el Manual de instalación y funcionamiento de KUMO.

Atenção! Ao conectar o KUMO a uma LAN padrão de IP estático, é preciso configurar os componentes do KUMO com um novo endereço IP exclusivo. Você deve primeiro conversar com seu administrador de rede e descobrir como ele deverá ser conectado (IP estático TCP/IP ou DHCP). O seu departamento de TI estará disponível para fornecer as informações necessárias para instalar o KUMO em uma LAN. Métodos para atribuir endereços IP estático são abordados no manual de Instalação e Operação do KUMO.

Attenzione! Quando si collega KUMO a un IP LAN statico standard, occorre configurare i componenti KUMO con un nuovo indirizzo IP univoco. Per prima cosa occorre parlare con l'amministratore di rete e scoprire come effettuare la connessione (IP statico TCP/IP o DHCP). Il reparto IT potrà fornire le informazioni necessarie per installare KUMO su una LAN. I metodi di assegnazione dell'indirizzo IP statico sono illustrati nel manuale KUMO Installazione e funzionamento.

Warranty Information

Limited Warranty

AJA Video Systems, Inc. (AJA Video) warrants that this product will be free from defects in materials and workmanship for a period of five years from the date of purchase. If a product proves to be defective during this warranty period, AJA Video, at its option, will either repair the defective product without charge for parts and labor, or will provide a replacement in exchange for the defective product.

In order to obtain service under this warranty, you the Customer, must notify AJA Video of the defect before the expiration of the warranty period and make suitable arrangements for the performance of service. The Customer shall be responsible for packaging and shipping the defective product to a designated service center nominated by AJA Video, with shipping charges prepaid. AJA Video shall pay for the return of the product to the Customer if the shipment is to a location within the country in which the AJA Video service center is located. Customer shall be responsible for paying all shipping charges, insurance, duties, taxes, and any other charges for products returned to any other locations.

This warranty shall not apply to any defect, failure or damage caused by improper use or improper or inadequate maintenance and care. AJA Video shall not be obligated to furnish service under this warranty a) to repair damage resulting from attempts by personnel other than AJA Video representatives to install, repair or service the product, b) to repair damage resulting from improper use or connection to incompatible equipment, c) to repair any damage or malfunction caused by the use of non-AJA Video parts or supplies, or d) to service a product that has been modified or integrated with other products when the effect of such a modification or integration increases the time or difficulty of servicing the product.

THIS WARRANTY IS GIVEN BY AJA VIDEO IN LIEU OF ANY OTHER WARRANTIES, EXPRESS OR IMPLIED. AJA VIDEO AND ITS VENDORS DISCLAIM ANY IMPLIED WARRANTIES OF MERCHANTABILITY OR FITNESS FOR A PARTICULAR PURPOSE. AJA VIDEO'S RESPONSIBILITY TO REPAIR OR REPLACE DEFECTIVE PRODUCTS IS THE WHOLE AND EXCLUSIVE REMEDY PROVIDED TO THE CUSTOMER FOR ANY INDIRECT, SPECIAL, INCIDENTAL OR CONSEQUENTIAL DAMAGES IRRESPECTIVE OF WHETHER AJA VIDEO OR THE VENDOR HAS ADVANCE NOTICE OF THE POSSIBILITY OF SUCH DAMAGES.

Index

A

- Apple Bonjour Print Services 23
- Auto Configure 14
 - default direct connection 14
- Auto Configured LAN 18
- auto discovery 15

B

- BNC connector
 - Dual mode 8, 37
 - Normal mode 8
 - Quad mode 8, 37
 - reference 8
- Bonjour 18
 - Win 7 installation 23
- button colors 37
- Button Key Caps 44
- Button Settings 37

C

- cable routing 13
- CAT-5 cross-over 14, 18, 35
- CAT-5 straight-through 14, 18, 35
- closed KUMO network 18
- color code buttons 37
- configuration
 - quick start 14
- Configuration page
 - KUMO CP 46
- Configuration screen 36
- connector
 - power 7
 - reference BNC 8
 - RJ45 8
 - RS-422 9
- control panel identify 46
- control panel resets 14
- cooling airspace 13
- cooling vents 13
- custom lens chips 44

D

- deactivate alarms 42
- default IP address
 - temporary 17
- default static IP address
 - procedure 17
- Destination
 - hide 38
 - lock 38

- shifted selection 45
- Destination buttons 36
- Destination Lock 44
- DHCP 18, 32
 - default setting 10, 14, 32
- dimensions
 - router 13
- direct connection auto configuration 14
- direct network connection 9
- Display Intensity 46
- DNS server 18
- DNSSD
 - accessing KUMO devices 26
 - Firefox installation 24
 - icon 25
- Download 39
- Dual mode
 - BNC connector 8, 37

E

- equipment interconnect steps 14
- error condition 41

F

- factory default static IP address 17
- features 7
- Firefox
 - device access with DNSSD 26
- firmware version 38

G

- GVG Native Protocol 9, 49

H

- hide Destination 38
- Home page
 - KUMO CP 45
- Home screen 36

I

- ID LED 8
- Identify button 42, 46
- Identify LEDs 42
- inputs
 - video 8
- installation summary 12
- installing software 39
- IP address 18
 - temporary default 17
- IP Reset 45

K

- KUMO
 - assign to KUMO CP with web browser 33
 - selecting from web browser 33
- KUMO CP
 - general description 43

L

- LAN 18
- LAN connection 10
- lens chips 44
- lock Destination 38

M

- MAC address 38, 46
- Manual 11
- mounting methods 13
- multi-router network 43

N

- navigation bar 35
- network
 - auto discovery 15
- network configuration
 - larger systems 29, 31
 - Mac Safari and Bonjour 15
 - Mac Safari and static IP 21
 - overview 18
 - Win 7 and UPnP 16
 - Win 7 browser and static IP 26
 - Win 7, Firefox, Bonjour 23
 - Win XP and UPnP 28
 - Win XP browser and static IP 29
 - Win XP, Firefox, Bonjour 29
- network configuration overview 9
- network connection
 - direct 9, 19
 - LAN 10, 19
- network connection methods 20
- Network page
 - KUMO CP 46
- network setting
 - default 10
- Normal mode
 - BNC connector 8

O

- outputs
 - video 8
- Over Temperature 41
- overview 6

P

- packaging 12

- Panel Lock 44
 - placement 13
- power connector 7
- power consumption 13
- power loss recovery 8
- power requirements 13
- power supply brick 7
- product features 7
- product overview 6

Q

- Quad mode
 - BNC connector 8, 37

R

- redundant power supplies 12, 60
- REF BNC 8
- remove Destination lock 44
- Reset Auto Configure 46
- Reset button (pinhole) 8
- Reset Buttons 45
- RJ45 connector 8
- Router Delegation Buttons 43, 44, 45
- RS-422 adapter 9
- RS-422 connector 9

S

- Safari browser 15
- Safeboot Reset 41, 45
- safety 12
- setting factory default static IP address 17
- Shift DEST 45
- Shift SRC 45
- shipping box contents 12
- Signal switching mode 36
- Source
 - shifted selection 45
- Source and Destination names 44
- Source buttons 36
- standard TCP-IP network 18
- static IP 32, 63
- static IP configuration 32
- Suppress 42
- System Name 38, 46

T

- TCP-IP 32
- TCP-IP setup fields 38, 46

U

- update files 39
- Update Network Settings 38, 46
- updates 38
- upload 39

UPnP 9, 18

V

video inputs 8

video outputs 8

video reference signal 41

W

WAN 31

web browser control capabilities 18

web browsers supported 18

web server 35

Z

zeroconf 18

Zero-configuration Bonjour Protocol 9

ZIP files 39